

1-1-2022

A Comprehensive Survey for Non-Intrusive Load Monitoring

EFE İSA TEZDE

ERAY YILDIZ

Follow this and additional works at: <https://journals.tubitak.gov.tr/elektrik>



Part of the [Computer Engineering Commons](#), [Computer Sciences Commons](#), and the [Electrical and Computer Engineering Commons](#)

Recommended Citation

TEZDE, EFE İSA and YILDIZ, ERAY (2022) "A Comprehensive Survey for Non-Intrusive Load Monitoring," *Turkish Journal of Electrical Engineering and Computer Sciences*: Vol. 30: No. 4, Article 2. <https://doi.org/10.55730/1300-0632.3842>

Available at: <https://journals.tubitak.gov.tr/elektrik/vol30/iss4/2>

This Article is brought to you for free and open access by TÜBİTAK Academic Journals. It has been accepted for inclusion in Turkish Journal of Electrical Engineering and Computer Sciences by an authorized editor of TÜBİTAK Academic Journals. For more information, please contact academic.publications@tubitak.gov.tr.

A Comprehensive Survey for Non-Intrusive Load Monitoring

Efe İsa TEZDE^{1,*}, Eray YILDIZ²

¹The Scientific and Technological Research Council of Turkey, Ankara, Turkey

²Electronics and Automation Department, Bartın Vocational School, Bartın University, Bartın, Turkey

Received: 19.11.2021

Accepted/Published Online: 03.02.2022

Final Version: 31.05.2022

Abstract: Energy-saving and efficiency are as important as benefiting from new energy sources to supply increasing energy demand globally. Energy demand and resources for energy saving should be managed effectively. Therefore, electrical loads need to be monitored and controlled. Demand-side energy management plays a vital role in achieving this objective. Energy management systems schedule an optimal operation program for these loads by obtaining more accurate and precise residential and commercial loads information. Different intelligent measurement applications and machine learning algorithms have been proposed for the measurement and control of electrical devices/loads used in buildings. Of these, nonintrusive load monitoring (NILM) is widely used to monitor loads and gather precise information about devices without affecting consumers. NILM is a load monitoring method that uses a total power or current signal taken from a single point in residential and commercial buildings. Therefore, its installation and maintenance costs are low compared to other load monitoring methods. This method consists of signal processing and machine learning processes such as event detection (optional), feature extraction and device identification after the total power or current signal is acquired. Up to now, many techniques have been proposed for each processes in the literature. In this paper, techniques used in NILM systems are classified and a comprehensive review is presented.

Key words: Energy management, signal processing, event detection, feature extraction, machine learning

1. Introduction

Today, residential loads have about 40% of total energy demand in developed countries [1]. As technology evolves and consumer comfort increases, so do the number of electrical appliances in homes. The increase in the number of appliances leads to an increase in energy demand, which causes to increase electricity bills of the consumers. More energy savings can be achieved by informing consumers about their electricity use and providing them with more detailed information on their consumption. Thus, energy savings in the residences will contribute to the reduction of total energy demand. However, nowadays the only feedback for consumers about their consumption is the monthly total electricity bill. Electricity bills alone cannot provide consumers with sufficient information about the electricity use in their homes. In many studies, providing real-time total power consumption information to consumers has significantly changed their electricity usage habits [2]. However, more energy saving can be achieved if they are provided with real-time power consumption information of individual devices directly [3, 4]. The smart meters store the energy consumption information and calculate the consumption charge based on time. However, consumers cannot access any consumption information of individual device consumption to save energy.

*Correspondence: efe.tezde@tubitak.gov.tr

A home energy management system (HEMS) is a system that schedules the operation time and the duration of the devices to use energy effectively and achieve cost saving in the home according to device parameters entered by the consumer, the electricity price, consumer preferences [5, 6]. Since the device parameters provided by the consumer are not precise information, the performance of HEMS may be insufficient than expected. If precise and accurate information is provided to HEMS by performing measurement about detailed power consumption of devices, HEMS achieve its purposes effectively. HEMS and the supplier can be provided detailed data about the individual devices by a method called load monitoring. Also, this may be important for the energy supplier to make a more stable production and supply a stable power to the consumer.

Load monitoring in residences is determined by monitoring each device directly or disaggregating the total power signal. The power consumption data of the device can be directly monitored in real-time via sensors (e.g. smart socket). Although this approach that called Intrusive Load Monitoring (ILM), provides more accurate results for power consumption and status of the devices, ILM requires a sensor infrastructure (sensors and in-house communications network) and special communication protocols and so it is costly [7]. Non-Intrusive Load Monitoring (NILM) is a method that determines power states and power consumption of devices by measuring total power data from a single point [8]. Since NILM employs a single point measurement and is lower cost, NILM has a broader range of use than the ILM. NILM enables users to monitor their loads remotely in commercial areas while also being able to provide necessary information to HEMS for fault detection. NILM has become a topic of interest for many researchers due to the new methods that have recently been emerged in signal processing and machine learning. The block diagram of NILM methods that consist of signal measurement, event detection, feature extraction, and device identification is given in Figure 1. However, not all steps in Figure 1 may be used in load disaggregation process. In particular, event detection is optionally preferred in the NILM flowchart. Therefore, NILM methods can be divided into two groups, event-based and non-event-based [9, 10]. Actually, it can be said that event detection step is algorithm dependent. Event-based methods involve an event detection step. In these methods, feature extraction and classification are performed directly at or around the time an event occurs. Therefore, event detection algorithms' performance play a vital role in event based NILM methods. Some miss events or false events worsen NILM method's performance as expected. Non-event based methods do not have an event detection step. Instead, these methods process every sample in the total aggregate signal (power, current, etc.) to identify appliances [9, 10]. Non-event-based NILM methods usually use Hidden Markov Models and its variants [11–13].

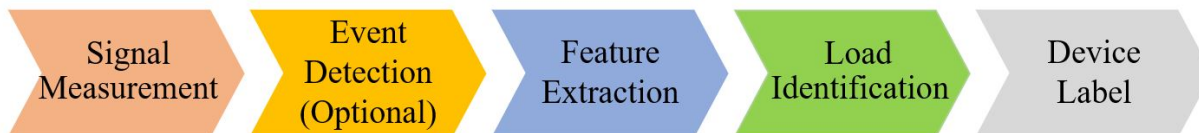

Figure 1. The flowchart of NILM methods.

It is costly to measure the power or current signal of each device individually via sensors. Therefore, the total power or total current signal of all devices in a residence is measured from a single point, as in Figure 2. Generally, measurements can be made from the electric meter or main breaker box covering all devices. The measured signals can be voltage-current signals or directly active and reactive power signals. However, sufficient sampling should be performed to disaggregate devices from the total power signal [14]. A high sampling frequency is needed to get transient state signals of devices clearly.

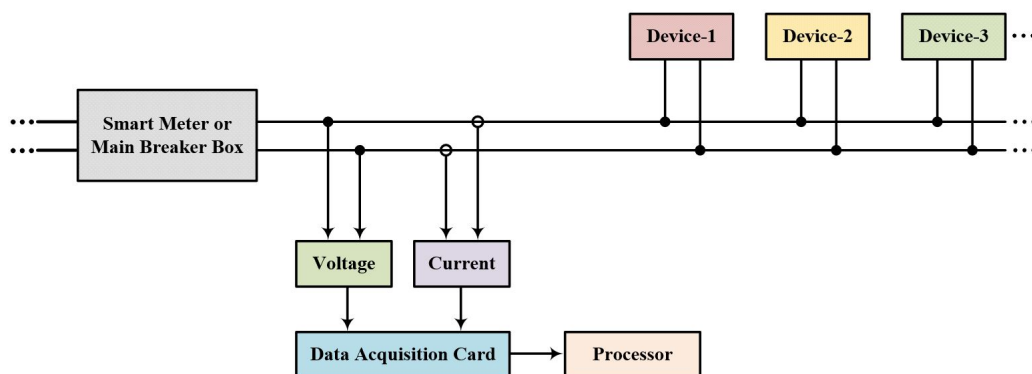

Figure 2. Acquisition of the aggregated power signal.

In this study, an overview of the device types in Section 2, the methods used to detect events corresponding to the state changes of the devices in Section 3, the extraction of the features specific to the devices used to disaggregate each device in Section 4, the identification of a device with the obtained features in Section 5, performance evaluations of the methods used are in Section 6, discussion and future work for NILM models in Section 7, and finally, the general conclusion for the review article is presented in Section 8.

2. Types of devices

The devices are basically divided into four categories according to the power that they consume and the situations that they have during their operation time. In the first study on NILM, the devices examined ON/OFF, finite state machine (FSM), and continuous variable [15, 16]. In addition to these, permanent consumer device has been defined in later years [17].

ON/OFF devices have two operation states and usually consist of a resistance load. It is seen in Figure 3.a that they consume approximately 20 W, while the lamp and toaster from these devices are turned on. While the device is ON for 70 to 260 s, it is OFF at other times.

FSM has multiple operating states. Water heater and hair dryer are among these device types. Figure 3.b shows four different operation states of an FSM device: state-1 (St1) in the range of 70-160 s, state-2 (St2) in the range of 160-220 s, state-3 (St3) in the range of 220-290 s, and state-4 (St4) in the interval of 290-360 s. Although it is simple to identify an FSM device in NILM, device identification can be complicated as the power consumption of these devices is aggregated when more than one device is turned on at the same time.

Unlike the two types of devices mentioned, the power of continuously variable devices alters throughout their operation, and these do not have specific operation states. Washing machine, dishwasher, and air conditioner are examples of this type of device. The power variation of an air conditioner is shown in Figure 3.c. As seen, its power consumption and operating time change each time the device is turned on. While identifying such devices in NILM, it is necessary to understand the operation characteristic of these devices and observe the model for a long time.

Permanent consumer devices (PCD) operate and consume constant power when energy is supplied. When they are ON, they are difficult to detect as they do not change state. The operation states of a smoke detector among PCDs is seen in Figure 3.d.

The four device types often mentioned in articles published on NILM are used. Technological advances in recent years have made device circuits more complex. Therefore, some researchers argued that this classification

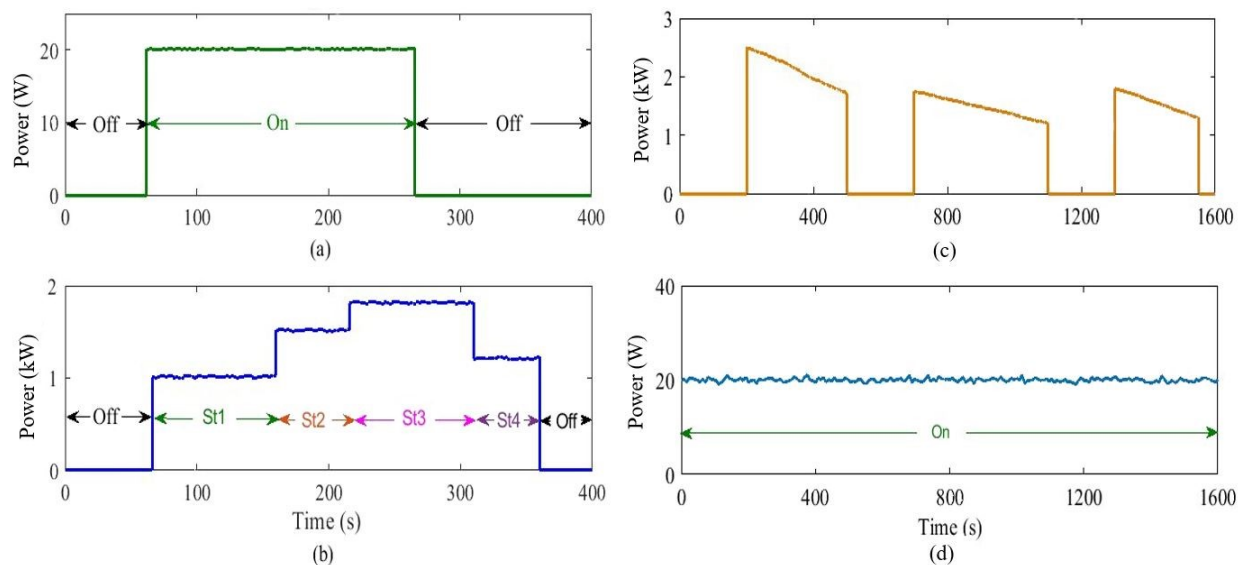

Figure 3. Appliance Types: (a) On/Off type, (b) FSM type (c) CV type, (d) PCD type.

was insufficient and suggested that device types should be redefined [18]. Because it is difficult, if not impossible, to distinguish similar loads supplied from the same power grid. The devices have been reclassified by adopting a prior knowledge approach according to the load's front-end circuit topology, electrical operating principle, functional nature, and user behavior. These are as follows: resistive loads (R), reactive dominant loads (X), electronic loads with power factor correction circuit (P), electronic loads without power factor correction circuit (NP), linear power supply using transformers to increase voltage (T), phase angle-controlled loads (PAC), and complex structures (M). It cannot be said that the new classification is very different from the previous four groups in terms of device characteristics.

3. Event detection

When the states of devices changes (switching on, off, or switching to a different operation state), their total power consumption changes. These state transitions are defined as events. An event, sometimes called an active section, is defined as the part of a signal that deviates from the previous steady-state [19]. An event finishes when the signal reaches a steady-state section. The purpose of event detection is to detect the times of state changes of devices and to facilitate device identification. When the state of a device changes, the change in the total power or current signal can be seen in Figure 4. Briefly, event detection looks for moments when meaningful changes in power consumption occur. Detection of these changes is easier for ON/OFF, FSM and PCDs but can be complicated in the detection of CVDs. In the literature, event detection methods have been examined in three different groups. These groups are called expert heuristic, probabilistic models, and matched filters [20]. In addition to these methods, there is an approach that is based on clustering.

In expert heuristic approaches, the absolute difference between the values of neighboring or adjacent samples in the total power signal is calculated to detect events, and it is checked whether this difference is above a predefined threshold. The algorithms in this approach are often less complex than probabilistic models and matched filters. The easiest method proposed is to find an absolute difference between the two adjacent samples in the total power signal and evaluate it according to a certain threshold value (15W) [21]. Various methods

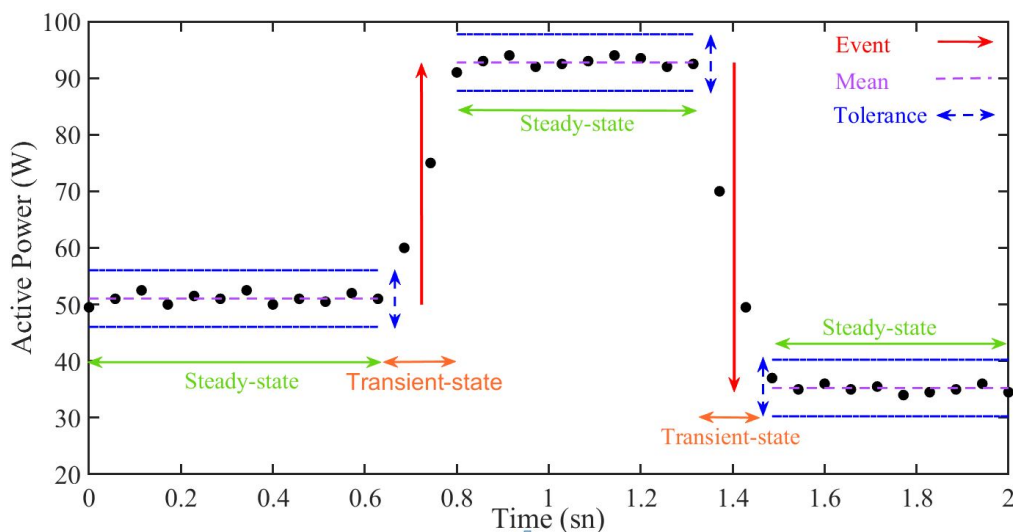

Figure 4. State transitions and events.

based on the perception of certain threshold-based change has been used in many studies in the literature [15, 22, 23]. To prevent the noises in the signal from being detected as an event, the total apparent power signal was filtered, and events were detected with the aid of the threshold (2VA) [24]. In [25], the absolute difference between two sequential samples was not directly calculated. Event detection is carried out by a threshold (75% of the smallest appliance's current) of the absolute magnitude of the RMS current signal between the present sample and the sample $t1$ (4 s) seconds ago. State transition duration of some devices can be a long. To detect such devices effectively, an event window with a $t1$ second period has been selected. This window allows sufficient time for the devices to settle into a steady state. However, when an event occurs due to the use of a $t1$ second window, more than one event is detected. To prevent these events, which are called false events, if an event has not been detected in the last $t2$ (3 sec) seconds, it can be defined as an event. However, the proposed approach causes the events occurring within $t2$ seconds not to detect correctly. In another study, steady-state sections are detected instead of directly identifying events, and the remaining sections are described as event regions [26]. For this approach, the segment-conjunction method and slope method have been proposed recently. Firstly, the segment-conjunction method divides entire data into small continuous data segments. Then, it checks whether they form a steady-state segment by evaluating the average value and standard deviation of n consecutive signal samples. It is decided to combine consecutive segments by considering the standard deviation of the mean values of consecutive steady-state segments. In the slope method, the slope between the two adjacent samples is calculated. If the slope is close to zero, it indicates the beginning of a stable zone, and sequential samples with a slope close to zero are added to this steady state region. A steady-state section detection continues in this way. Signal samples where the slope is different from zero terminate a steady state section. When the slope is close to zero again, the beginning of a steady state section is detected.

A recent study proposes a hybrid method to detect events of appliances with long transients, high fluctuations, and/or near-simultaneous actions [27]. The method contains one base algorithm and two auxiliary algorithms. The purpose of the auxiliary algorithms is to detect true events and remove false ones. The first algorithm, base algorithm, detects events with moving average change and removes false events by using a time threshold (0.2 sec). Until a steady-state is reached, some appliances cause nonstop false alarms due to their long

and complex transient period. To handle such appliances with long and complex transitions, the method applies a derivative analysis algorithm. Different reasons such as its circuit structure, voltage oscillation, appliances interaction create fluctuations in a signal. When fluctuation reaches a higher value, false alarms are triggered. To detect such false alarms, a filtering analysis algorithm is used.

Event detection with probabilistic models is performed in two steps. Firstly, the probability of an event occurring in each sample of the power signal is calculated. The resulting signal is called the detection statistics signal. This signal is obtained by applying statistical tests such as generalized likelihood rate (GLR) [28], goodness of fit [29], cumulative sum [30, 31], mathematical functions [32] by means of window shift to the total power signal. Besides, a log-likelihood detector, inspired by GLR and its modified version [8], was proposed [33]. A recent study uses the envelope of the current signal as the detection statistics signal [19]. Secondly, power events are extracted from the resulting detection statistics signal. The zones where the detection statistics signal is above a certain threshold are marked as an event in the power signal. For some cases, the selection of power events is found by applying a voting algorithm or a maximum/minimum locating algorithm to the statistical detection signal [19, 33–35].

In matched filter method, the presence of the initial transient state signals of the devices in the total power signal is sought to detect events. These signals are correlated with the total power signal by using filters. In a study that used two sequential filters, an event detection was proposed to match the initial power signals with the total power signal [36]. The initial transient state signal of each device was obtained in training. While the first filter finds temporary patterns in the total power signal, the second filter ensures that the matches do not have some random noises and correspond to real transitions. In a different study, Hilbert filter was used with matched filters [37]. Hilbert filter was followed by a combination of mean and derivative filters; thus, events were detected from the instantaneous current signal.

In clustering-based methods, unsupervised clustering techniques are used to cluster real and reactive power measurements in the PQ plane (PQ plane is defined in the section 4). Measurements that belong to a steady-state section are considered as a cluster. Furthermore, samples, which are in transient intervals, are considered as noise or outliers. In the seminal work for clustering-based methods, the steady-state sections and transient sections are obtained by using a robust bucketing technique and unsupervised clustering [38]. In this study, M is used to denote the true number of clusters for steady-states. The bucketing technique is the first applied to estimate model order M . Then, the detection of the steady-state sections and transient sections is performed by unsupervised clustering with expectation maximization (EM) algorithm and Gaussian mixture model (GMM) of the unfiltered raw active (P) and reactive (Q) power signal. To enhance performance, some modifications were proposed later [39]. In this event detector, there are three main steps which are called coarse event detection, fine event detection and verification. In the first step, coarse event segments each of which contains only one transient section are detected by using a window. This window is widened iteratively until the model order estimation, which is based on the eight-neighborhood rule, detects two clusters. Therefore, each coarse events have only two steady state and one transient section. Expectedly, time limits of each detected coarse event are determined in the fine event detection step. To do this, the unsupervised Expectation Maximization (EM) the clustering algorithm is used to detect a fine event from each coarse event. The verification step is performed for verification of detected events and parameter adjustment. Recently, a moving windowed based density-based spatial clustering of applications with noise (DBSCAN) algorithm was proposed for event detection [40]. The active power and fundamental current RMS curve are windowed; the DBSCAN clustering technique is used to detect transient section. The window length is chosen according

to the longest transient interval. Therefore, it should have a value that is larger than the longest transient interval. Another constraint about window length is that the window always contains only two steady state and one transient section. So that clustering algorithm distinguishes only two clusters. After all, there is a post processing step to eliminate repeated and unreasonable detection results.

4. Feature extraction

Obtaining features from the measured total power signal is called feature extraction. In the literature, device features are also known as device characteristic or device signature. To maximize recognition accuracy and identify various devices effectively, choosing appropriate feature extraction methods play a vital role in load disaggregation. Various approaches to feature extraction are used in the literature. Feature extraction methods for load identification can be classified as steady-state, transient state and nontraditional [14]. As seen in the paper, these feature extraction methods can be used alone or in combination in the literature.

In the literature, various sampling rates have been used to extract features. The sampling rate of an aggregate signal in NILM must be determined according to the type of feature extracted from the aggregate signal. There are a lot of studies for steady state features extracted by using frequency range from 1 Hz to a few kHz. In [15], Active and Reactive Power features are extracted from a aggregate active and reactive power signals sampled at 1 Hz. Some of steady state features such as current harmonics are required to be sampled at a higher frequency of a few kHz. This sampling frequency must be determined according to Nyquist–Shannon sampling theorem; for example a minimum sampling frequency of 600 Hz is required to obtain 5th harmonic of the electrical signals for power line frequency of 60 Hz [14, 41]. Since transitions in the transient states occur in a short time, the transient features often need a higher sampling frequency compared to the steady state features. In [42], voltage and current signals are sampled at 30 kHz to extract the transient response duration and transient energy features which are in transient state features. In [43], the switching transients are sampled at 5.21 MHz to be used in transient state feature extraction.

4.1. Steady state features

If the absolute differences of the neighboring sample values in a part of the total power signal are within a certain threshold value, this part of the signal is called steady state. Figure 4. shows three steady-state regions for the total power signal. When the state of an appliance is switched to a different operation state, this causes the properties of an aggregate signal (power or current) to change. To use these changing properties, a steady state feature is extracted from steady state regions of an aggregate total signals (power or current). For example, the change (difference) in the total active power signal for ON/OFF transitions of devices is called the active power signature for this device. Device features such as active power, reactive power, current harmonics, total harmonic distortion, effective current value, power factor, phase angle and admittance are obtained from steady state regions and are widely used in NILM methods. In the seminal works in the field of NILM, the changes in the total power signal due to the states of the devices were used as the distinctive features of the devices. In the events of ON/OFF devices such as refrigerators, ovens, and electric stoves, step changes in the active power signal can be seen in Figure 5.a. Only the active power feature was used in the first studies in the literature to identify high power devices such as kettle and refrigerator [44–46]. Since the active power consumptions of these devices are different from each other, device identification has been successfully accomplished. Using only active power change as a device feature creates a big disadvantage. Because the expected performance cannot be achieved for devices with similar active power consumption. To overcome this problem, active power and

reactive power changes were used together for device signature [15, 47]. In this study, while using on/off and FSM devices, the active-reactive power distributions of the devices are shown in Figure 5.b in the P-Q plane. Low power device clusters appear to be close to each other in the P-Q plane. For this reason, the active-reactive power change feature is insufficient to classify devices with low power consumption. On the other hand, power consumption has been successful in distinguishing different high-power devices. However, in this study, CV and PCD type devices were not used. In addition to active-reactive power features, apparent power feature has also been used to improve device identification performance [48].

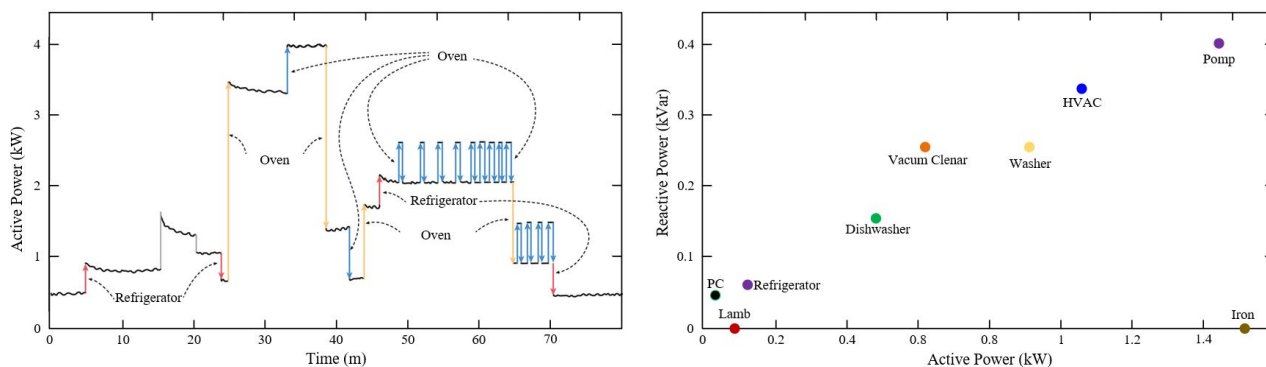

Figure 5. (a) Active power [15], (b) real-reactive power distribution [14].

While the current waveform of a linear load is sinusoidal, the waveform of the current drawn is irregular for a nonlinear load. When this irregular current signal is analyzed by Fourier analysis, it is seen that it contains harmonics that are multiples of the fundamental frequency. Devices such as hairdryer and water heaters can be given as examples of linear load, and devices such as induction heating, fluorescent lamp, and computers are non-linear loads. An induction cooker draws a current containing high order harmonics while a kettle fed from the same source draws a sinusoidal current. Consequently, current harmonics can be used as a distinctive device signature in steady-state regions for nonlinear loads. When the current harmonics feature is used with active-reactive power change features, it appears that the combined features provide better results [49, 50]. In addition, another study utilized the total harmonic distortion of the current, which indicates the level of harmonic distortion in the power system [51]. To analyze and determine the aging characteristics of the loads in the homes, current harmonics and total harmonic distortion of the voltage are used in addition to the active-reactive power in the feature extraction [52]. Effective current value, peak current value, phase difference, and power factor features obtained from voltage and current signals have been used in ON/OFF type devices for steady-state analysis in various studies [53, 54].

To extract the electrical characteristics of devices, curves called trajectories are obtained by plotting the steady-state voltage and current signals over a period-length in the voltage-current plane. Current-voltage trajectories of devices such as ovens, laptops, televisions, and air conditioners are shown in Figure 6. Although the shape of the voltage-current trajectory in the same brands and model devices is similar, the size of the trajectories may not be the same due to differences in the power consumption of the device. The current magnitude can affect the size of the V - I trajectory on the vertical axis. To eliminate this, the voltage and current values must be normalized to have the same scale [55].

After the trajectories of the devices are plotted, various features are extracted on the shapes of the curves. Asymmetry, loop direction, area, mean line curvature, number of intersections, mid-section curvature,

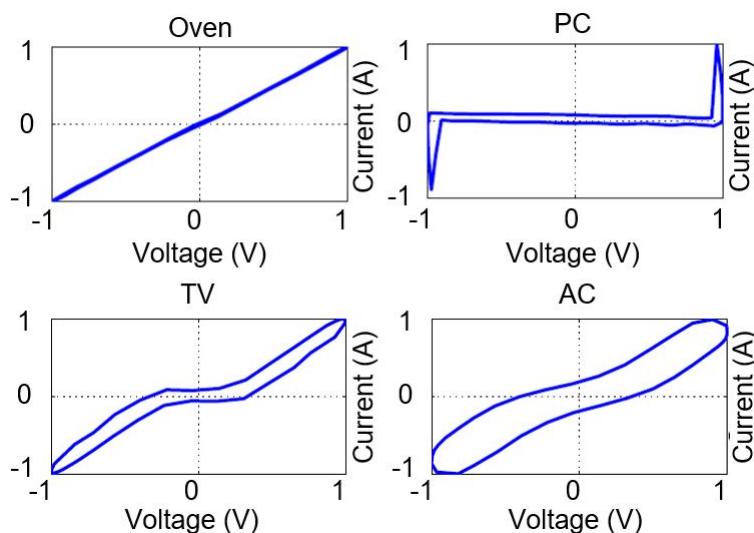

Figure 6. Examples of V - I trajectory [59].

right and left areas, and the so-called peak value of the middle part are obtained over V - I trajectories [55, 56]. In addition to these features, the current range and instantaneous admittance change features were obtained from the trajectories [57, 58]. Apart from these, V - I_f and V - I_a trajectories were plotted by separating the load current into components called active I_a and inactive I_f currents and features obtained from these trajectories increased the performance of device identification [59].

Recently, recurrence plot [60] has been proposed to extract features from steady state total current waveform [61]. A recurrence plot is a monochrome digital image, each pixel of which represents recurrent states of a time series in its m -dimensional phase space trajectory. As a recurrence plot is a binary image, this feature extraction technique can cause information loss and decrease classification performance. Therefore, novel and modified versions of the recurrence plot, which are called weighted recurrence graph and adaptive weighted recurrence graph has been also proposed [62, 63]. Comparing to recurrence plot, these methods improve classification performance.

4.2. Transient state features

The regions between the two steady states are called transient state regions, as seen in Figure 4. These regions occur due to the switching (ON/OFF transitions) of the devices or the temporary behaviors they display in case of state changes of devices. Distinctive features can be obtained from the temporary behavior of the devices [20].

The shape, duration, and time constant features in the power signal can be extracted from transient state regions of the devices [15]. For example, if the transient state region of the dishwasher and computer are examined, it will be seen that the shapes, transition duration, and number of passes are different. In a study using an induction motor and fluorescent lamp in this regard, parts of a transient state region with significant changes, called v -sections, were obtained as shown in Figure 7, instead of examining the entire of a transient state region [64, 65]. Then, the desired features are extracted with the help of filters to distinguish each device. If the v -sections of the devices that start operating simultaneously do not overlap, the devices can be disaggregated properly. While load disaggregation fails if the v -sections of the devices overlap.

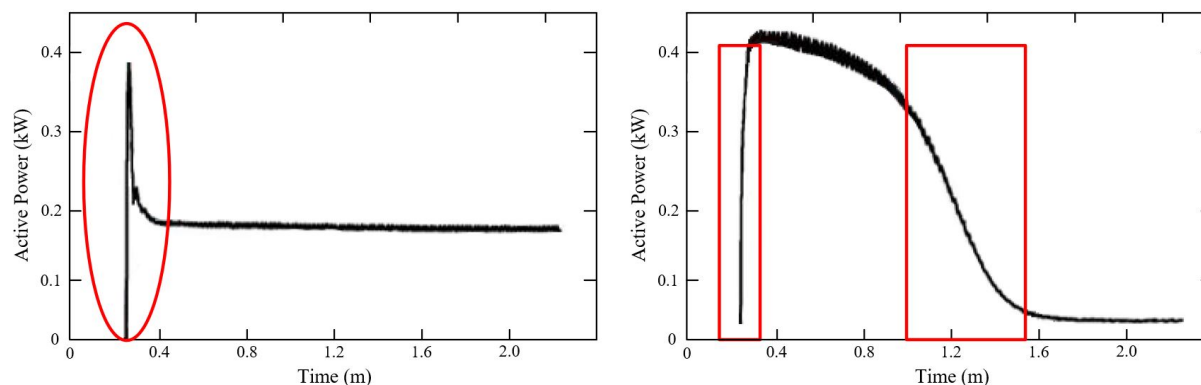

Figure 7. Active power transients for lamb and induction motor, v-sections [36].

For residential devices that exhibit sudden power peak in total power consumption, two features called edge and slope have been proposed [66, 67]. In these studies, the transient state signatures of residential loads were characterized by three stages (an initial upward spike in power, slower changing variations, and a settled power level). These three stages are called edges, slopes, and steady-states, respectively. The edge feature refers to the sudden power peak when the device is turned on, and the slope feature refers to the slow variations following the edge. Although these features are easy to obtain due to the low frequency required, they are insufficient in identifying multistate and nonlinear devices.

Spectral envelopes, which are the expanded version of harmonics, are the vector consisting of the first few coefficients of the short-time Fourier transform (STFT) applied to a signal. It can also be thought of as the short-term average of the harmonics of a signal. Unlike FFT, where timing information is lost when converting the signal to the frequency domain, STFT uses a fixed window to convert a small portion of the signal at once. Thus, by converting the signal into a two-dimensional function consisting of frequency and time, it preserves time data. As a result, the spectral envelope was used as feature extraction in load disaggregation [17, 68].

Fourier transform (FT) consists of the sum of the periodic signal with an infinite duration. However, transient signals are neither periodic nor infinite. Therefore, it is not appropriate to use FT in transient state signals. Wavelet methods have been proposed to overcome this disadvantage. Wavelets are mathematical functions that are more advantageous than the Fourier transform method for transient state analysis of signals. Instead of identifying a signal with trigonometric polynomials by wavelet transform, it can be decomposed by combinations of short-term non-periodic functions derived from the shifted and scaled main wavelet function [43]. Discrete wavelet transform (DWT) and STFT have been applied to the switching transients that occur on voltage signals as seen in Figure 8 in the disaggregation of devices consisting of fan, blender and bulb. When the results are examined, DWT has been more successful in detecting device identities [43]. In another study, a five-element normalized energy vector was obtained using DWT from the current signal containing harmonics and was used as features in load disaggregation [69]. Switching transition energy feature has been obtained by using DWT in separating the devices consisting of two different induction motors and adjustable load banks. It has been observed that this feature is used by combining with the active-reactive power feature to increase performance [70, 71]. In addition to the switching transition feature, the transition duration feature obtained with DWT or STFT has also been proposed [42]. When these features are used with DWT, they give better results than STFT. In a study involving three-phase motors and resistive loads, the energies of the coefficients

obtained by using DWT were used as features [72]. In this study, it was seen that Daubechies wavelet gave better results at 4 and later degrees when compared with various degrees.

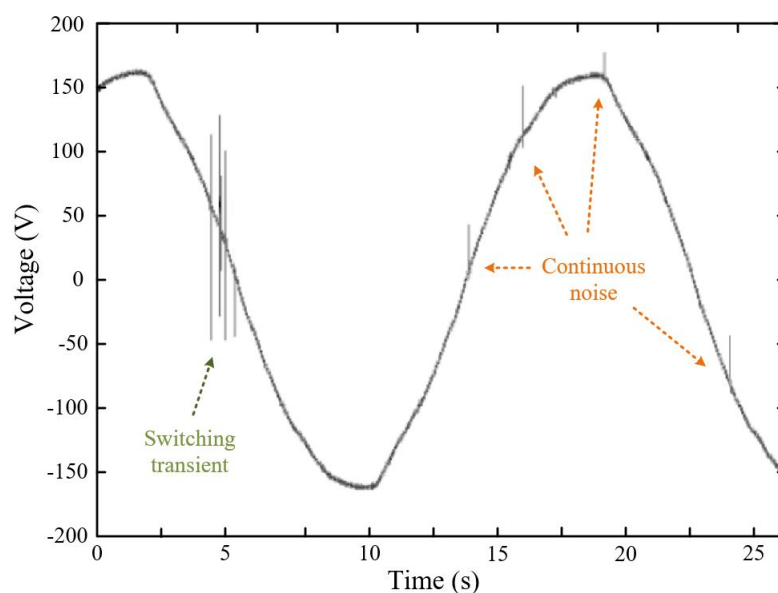

Figure 8. Voltage switching transient for blender [43].

4.3. Nontraditional features

There are several feature extraction techniques for load disaggregation that do not fit the steady state and transient feature categories. Features such as the frequency of device usage, the correlation between the usage of different devices, the distribution of turn-on duration and turn-off duration of the devices, and operation time of the devices have been studied in various studies [73, 74]. In a study where an active power signal sampled with low sampling frequency is used, the first derivative is applied to the flattened power signal, and pulse signals are removed. In addition, additional human behavior information such as the probability of device usage time, probability of neighboring impact search, duration of impact has been added [75]. In another study, the power consumption of residential loads is also expressed with the combination of rectangular and triangular form combinations [76]. This approach is based on dividing the power consumption signal into two parts. The fast-switching region in triangular form and the stable working region in the rectangular form are approximate. The triangle shape is defined by the start time, peak time, peak value, and end time. The rectangular shape is defined by start time, peak time, peak value, steady-state start time, and steady-state power. These definitions are shown in Figure 9.

In a recent study [77], authors use a local power histogram (LPH) feature extraction scheme based on transforming the appliance consumption signals into 2D space. This feature extraction technique does not rely on the device's states (i.e., steady or transient). It transforms the appliance consumption signals into images. To obtain local features, it partitions images into local region. Then, it uses an LPH descriptor to extract histogram-based representations of power observations. It has been shown that LPH performs well by comparing with existing 2D descriptors in the literature such as Local directional patterns (LDP), local ternary pattern (LTtP), local transitional pattern (LTrP), Local binary pattern (LBP), Binarized statistical image features (BSIF). A current envelope-based feature extraction technique was proposed to disaggregate

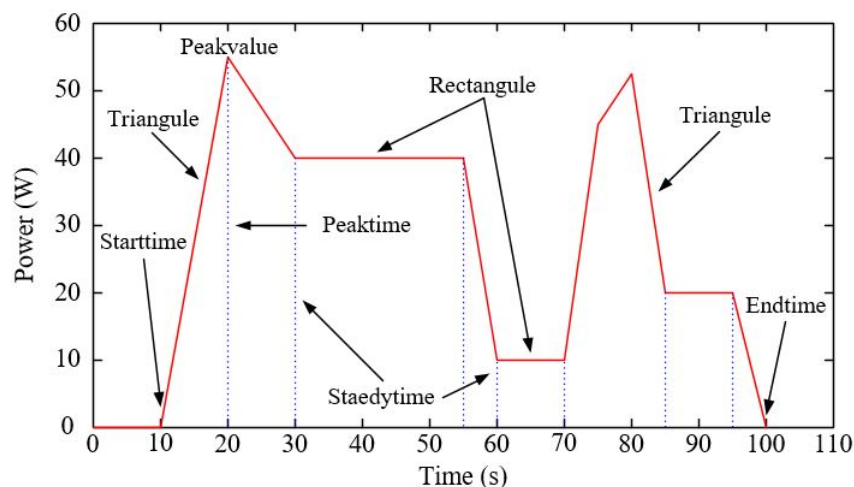

Figure 9. Diagram of triangles and rectangles [76].

appliances by using both transient and steady state current waveforms [78]. By analyzing the obtained current envelope, it extracts seven statistical features called Interquartile Range (IQR), Crest Factor (CF), Variance, Kurtosis, Skewness, Form Factor (FF), and Mean Absolute Deviation (MAD).

5. Load identification

Load identification, one of the most important steps of NILM, is the process of labeling devices based on the features extracted from the measured total power signal. When studies on NILM about this subject are reviewed, they can be grouped as supervised, semi-supervised, and unsupervised learning methods.

In supervised learning, a classifier is determined with the training set consisting of device features and class labels. Intrusive and nonintrusive methods can perform the training sets required for the training process. Although supervised learning achieves high performances, the data collection and training process are a disadvantage for NILM. Supervised NILM methods are the first and most widely preferred approach in this realm, and it can also be divided into two classes based on pattern recognition and optimization [9].

Unsupervised learning is an approach which data samples with similar features are clustered by taking advantage of only device features. This approach does not require class labels and a training process. Although this approach is the most suitable method for NILM, it is more difficult to achieve a successful result compared to supervised learning. It is determined by the consumer which device and which its state the clusters obtained by unsupervised learning belong to. Therefore, this process is a disadvantage for unsupervised NILM methods.

Semi-supervised learning utilizes a combination of both labeled and unlabeled data for training. Generally, labeled data samples are less than unlabeled. When recent studies on NILM are reviewed, it is seen that there is an increasing interest in semisupervised learning methods.

5.1. Supervised methods

5.1.1. Pattern recognition approaches

In the literature, artificial neural network (ANN), support vector machines (SVM), k-Nearest Neighbor (k-NN), Hidden Markov Model (HMM), Decision Tree (DT), Random Forest (RF) and Deep Learning (DL) for pattern recognition-based load disaggregation methods were used. However, there is no study for NILM, where all of

these methods are compared in detail in terms of performance. Therefore, there is no certain conclusion about which of these methods is more successful. In addition, depending on the types of devices used and the features extracted from the devices, the performance of these methods varies.

Multilayer perceptron (MLP) and radial basis function networks (RBF), which are among the ANN methods, have been found to be frequently used in the literature for load disaggregation. In one of these studies, classifications were made for the combinations of 8 devices created according to ON/OFF working conditions [49]. In the study, while steady state harmonics feature is used, the performances of the classifiers are also examined under the effect of noise. There is another study where genetic algorithm (GA) was used for feature selection, transient state energy, and active-reactive power features were used [79]. The training phase of MLP was carried out using all the features obtained first and then the features obtained through the selection of the features. It is stated that the performance of the MLP trained by the feature selection is more successful. In a different study, the weight values of MLP were determined by PSO and GA optimization methods and the performance of ANN in terms of accuracy and duration were examined [80]. The ANN, trained with the PSO algorithm, has been found to give better results for voltage variation on device terminals, variations in power consumption and different operating states compared to other methods. Recently, convolutional neural networks (CNN) has gained popularity in NILM [62, 63]. Again, by using two popular data sets, called PLAID [81] and WHITED [82], CNN have been studied recently. In this study, Weighted pixelated images obtained from the V - I trajectory feature were used as inputs for CNN [58].

Using the linear and radial basis function (RBF) kernels, SVM has been studied in detail in NILM studies using features such as active-reactive power and power factor [54]. In addition, while studying the noise effect in this study, it used the wavelet shrinkage method to suppress the noise. Also in a recent study, the GA method was utilized to determine the parameters of the RBF kernel [83].

In the study in which the NILM method first appeared, the cluster analysis approach was used in the P-Q plane [10]. Here, new samples based on active and reactive power changes occurring in each event detection are classified according to the cluster in the P-Q plane in Figure 5.b. The proposed cluster analysis has been used in other studies by adding different features such as current harmonics and active-reactive power features, which are inadequate due to overlapping clusters [36, 84]. k-NN method, which is similar to cluster analysis and described as a simple method, has been shown to yield successful results for the $k = 1$ value according to naive Bayes and decision trees methods [8]. In a study where the samples obtained from the total load signal with the temporal sliding window were labeled for more than one device [85], the multi-label k-NN method was used for load identification. In addition, it has been observed that the classification performance has increased recently when k-NN and template matching methods are used together [86]. In a recent study, an improved k-nearest neighbors (IKNN) algorithm is proposed to reduce the learning computation time and improve the classification performance [77]. To reduce computation time, the proposed algorithm uses conditional entropy to split training data into m subgroups and compute the distance between the test instance and center of each subgroup. In addition to this, it uses information gain as weights to calculate weighted Euclidean distance.

HMM, another method of device identification, determines the order of hidden states that best represent the outputs. While the active power signal is usually used as output for load disaggregation, hidden states represent the states of the devices. There are important studies in the literature showing the suitability of HMM method for load disaggregation [87–89]. In these studies, the states of each device are modeled separately with HMM, and then these models are combined for the operation states of multiple devices. Although the

HMM method can cope with the states of the devices, although it generally gives successful results in load separation, the complexity of HMM increases exponentially when the number of devices increases [14].

DT is less preferred in load disaggregation because of the low success rate compared to the other mentioned pattern recognition methods. In a study where three pattern recognition methods were compared with DT, the most successful method was k-NN, while DT could not achieve the desired success [90]. In a study where low sampling was prioritized, DT gave more successful results than HMM method [91]. Based on this, it can be said that the DT method gives successful results in low sampling frequency systems [92]. In another study, GA was used for feature extraction and feature selection with a high degree of statistics, whereas DT and MLP methods showed 99.5% accuracy [93]. There are also studies involving RF method that makes learning with more than one decision tree [94, 95]. In a study comparing DT, RF, k-NN, and SVM methods, while the admittance-based feature extraction was used, the most successful result was the SVM method [94]. DT and RF also failed compared to the other two methods.

Naive bayes classifier based on Bayes Theorem has been used in various studies [74],[96],[97]. The classifier generally assumes that there is independence between the individual features [74],[96],[97]. In [96], a two-step classification algorithm have been used: The first step identifies the load type (linear nonreactive, linear reactive or nonlinear reactive) by using the rate of change of the transient signal as feature and in the second step, naive Bayes classifier is used to classify the appliances by using steady-state current harmonics as feature. In [98], naive Bayes classifier is used by assuming that each device's state is completely independent of the other devices.

5.1.2. Optimization based approaches

Optimization-based approaches often identify devices by a combination that represents the total power signal with the least error. Starting with a random device combination, Genetic Algorithm (GA) tries to identify them by finding the devices that give the total power with minimum error [99]. An evolutionary optimization algorithm has been proposed to identify devices modeled as ON/OFF in a residence [100]. In this study, evolutionary optimization was evaluated using randomly generated power profiles and total power to explain the applicability of the evolutionary algorithm in NILM. The results showed that it is possible to use the evolutionary approach in NILM, and it has satisfactory performance. In a study that expresses the operating states of the devices as integer variables, second-order integer programming was used [101]. In this method, even if a new device is added to the home, the re-learning process is not required. The proposed method has also shown its applicability, while the same type of devices is operating simultaneously. Load disaggregation based on Aided Linear Integer Programming (ALIP) has recently been proposed [102]. In addition to the LIP-based disaggregation approach, additional constraints, state diagram-based correction, and median filtering have been added. The proposed ALIP is based on momentary load measurements instead of the waveform features of the measured parameters. Therefore, it is successful in low frequency data. Experimental results confirm that the proposed ALIP performs better than LIP based load disaggregation method. A workflow using surrogate-based optimization (SBO) has been introduced that is sensitive to differences in NILM's base load power consumption and can meet the need for comprehensive parameter optimization. In this study, a modified version of the chi-square goodness of fit (χ^2 GOF) test and an event detection method based on cepstrum smoothing were used [103]. While most classical NILM algorithms are based on a single objective function, a multi-objective non-intrusive load monitoring (MO-NILM) method that classifies NILM events by solving a multiobjective optimization problem have been proposed. Basically, it is intended to model each NILM feature as an objective

function and to minimize these goals based on the Non-dominated Sorting GA II (NSGA-II). The proposed algorithm is simple, requires knowledge of the average power signatures of each appliance, and performs well in terms of standard measures [104].

5.2. Unsupervised methods

The training process in supervised NILM methods makes it difficult to use these methods in residences and commercial areas, as data should be collected in advance and the data collected should be labeled. Therefore, researchers have started to show more interest to unsupervised NILM methods recently. While active and reactive power features are used in a study involving devices used in residences, genetic k-means and hierarchical aggregate aggregation methods were used to cluster state changes of devices in the P-Q plane [105]. It was assumed that each cluster coincided with a state change of a device, while better clustering was performed with genetic k-means. When a new event occurs with a matching pursuit algorithm after clustering, it determined which device or devices caused this event using Euclidean distance. Again, only active power attribute was used in another study using low sampling frequency, while Entropy Index Constraints Competitive Agglomeration method was used [106]. Unlike the previous study, this method has yielded successful results in low-power devices.

By using low frequency sampling, Factorial HMM (FH-MM) and FHMM based Factorial Hidden Semi-Markov Model (FHSMM), Conditional FHMM (CFHMM) and Conditional FHSMM (CFHSMM) were proposed [73]. Factorial HMM (FHMM) is a method that includes hidden state models operating independently and parallels to each other, as seen in Figure 10, and the output Y is a function of these states [107]. In this study, while assuming that the devices have only ON/OFF states, in addition to the active power attribute, additional features called ON/OFF time, operation time during the day, weekly operation time and interconnectedness between the devices are also used. While estimating the parameters of the models, the expectation maximization algorithm was used. Conditional states of FSMM and FHSMM methods were obtained by using additional attributes. The CFHSMM method, which can use these additional attributes, has been more successful than other methods. In another study using the FHMM method as a base, it is said that some devices affect each other's power consumption when more than one device is ON [108]. A more successful method was obtained compared to FHMM method by adding this interaction information of each device using additional interaction chains in the FHMM method.

Graph signal processing (GSP) is another unsupervised method used recently in NILM [109, 110]. It is defined by a set of graph nodes and the neighborhood matrix showing the similarities or correlations of the edges between these nodes. In this method, where each node coincides with the events, clustering of similar events was performed as a result of the solution of an unconstrained second-order optimization problem. It has provided successful results according to the unsupervised HMM methods in the identification of loads used in the residences.

5.3. Semisupervised methods

Unlike supervised and unsupervised learning, semi-supervised learning methods use both labeled data and unlabeled data and try to improve the performance of the classification process with the help of unlabeled data. In one of the prominent studies on semi-supervised NILM, self-training was carried out using the k-NN method [111]. Self-learning uses the self-training principle by using its own predictions in the learning step. This method is based on the principle that the unlabeled data samples are included in the device classes they are close to by

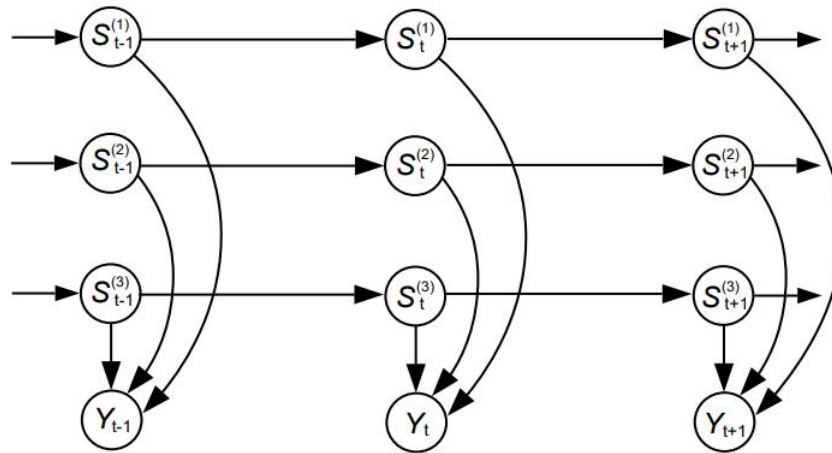

Figure 10. The graphical representation of Factorial HMM [107].

using the distance from the device classes. To prevent the device identification from decreasing the performance by distributing all the unlabeled data samples to the device classes, a stop criterion that enables the addition of a certain number of samples was also determined. In another study, training was made on decision tree and k-NN methods using the co-training approach [112]. The labeled training data was divided into two and training was provided for the two methods with different training sets. A subset chosen randomly from the unlabeled data set is presented to two classifiers. Unlabeled samples, where both classifiers were given the same class label, were used to update the classifiers. This process was continued until all unlabeled data were finished.

6. Evaluating NILM algorithms

6.1. Datasets

A lot of datasets have been proposed by researchers in the last decade to evaluate novel NILM models and compare their performance. These datasets can be divided into two groups [113]: low frequency datasets (sampling frequency, $F_s < 1$ Hz) and high frequency datasets (sampling frequency, $F_s > 1$ Hz). Popular datasets in NILM can be seen in Table 1 in terms of their properties. Collecting data for a dataset is time consuming and needs measurement equipment. Recently, synthetic data generation for use in NILM has gained popularity to reduce cost, save time, and prevent issues such as corrupted data or missing values [114]. In the table, SynD is a synthetic dataset, and LIT is a dataset composed of natural data and synthetic data.

6.2. Metrics

In the literature, there are many performance metrics proposed from the seminal work of NILM until now [123, 124]. For event-based NILM methods, there are two steps (event detection and load identification) that affect the method's performance. Therefore, it is not forgotten that performance of event detection step should be maximized to increase the overall performance of the NILM methods. Whereas, there isn't such a problem for nonevent based NILM methods. Most of NILM methods uses accuracy (A) and Confusion Matrix (CF) as principal evaluation metrics [14]. In the seminal work of NILM [15], the fraction of correctly classified power events and the fraction of total energy explained were used to evaluate the method. In some studies [49, 125], accuracy for individual devices and average accuracy are used to evaluate the proposed method. Accuracy alone

Table . Publicly available load monitoring and disaggregation datasets.

Dataset	Year	F_s	Features
REDD [115]	2011	15 kHz	I, V, P
BLUED [116]	2012	12 kHz	I, V, P, Q
PLAID [81]	2014	30 kHz	I, V
TRACEBASE [117]	2014	1 Hz	P, Np
GREEND [118]	2014	1 Hz	P
UK-DALE [119]	2015	16 kHz	I, V, P, Q, S
COOLL [120]	2016	100 kHz	I, V
WHITED [82]	2016	440.1 kHz	I, V
SustDataED [121]	2016	12.8 kHz	I, V
BLOND [122]	2018	50 - 250 kHz	I, V, P
SynD [114]	2020	5 Hz	P
LIT [113]	2020	15 kHz	I, V

can be misleading for some situations such as: class imbalance or low usage frequency of some appliances. To alleviate such problems, some studies use precision (P), recall (R) and F-measure to evaluate NILM methods [54, 126, 127]. Two modified versions of f-measure are proposed by splitting true positive (TP) into accurate true positive (ATP) and inaccurate true positive (ITP) to apply the metric to multistate appliances [73, 126, 128]. In [129], to evaluate the proposed method three metrics are used: detection accuracy, disaggregation accuracy and overall accuracy. While detection accuracy evaluates a method by including wrongfully detected events, disaggregation accuracy is a metrics to evaluate a method by excluding wrongfully detected events. Overall accuracy evaluates a method by including missing events but excluding wrongfully detected events. Apart from these metrics, to evaluate disaggregation of total aggregate signals (current or power) into each appliance some metrics are proposed in the literature. Root mean square error (RMSE) is used to evaluate the deviation of predicted power and actual power of appliances [130, 131]. In [115, 132, 133], a metric called as total energy correctedly assigned (TECA) is used to evaluate the amount of energy that was correctly classified.

7. Discussion and future work

7.1. Discussion

NILM is a topic that has been researched since the last quarter of the 20th century. Many researchers in the academic world have developed original NILM models. However, many of these models are not usable in real-world applications. The datasets created by the measurements made while the devices are operating in the laboratory are run with the algorithms developed by the researchers. Its performance can be improved by changing or updating the parameters of the algorithm. Whether the developed models can be applied and adapted without any problems in all residences is questioned among researchers.

NILM algorithms have the function of distinguishing based on device characteristics. The fact that the residences have constantly variable loads, and the operation characteristics of similar device types do not overlap those in the laboratory, cause difficulties in the applicability of the algorithms. In addition, the increase in the number of devices and new devices added to the house increase the evaluation time of the algorithm, but reduce the performance of the algorithm. Since the device features in the laboratory are different from the features in

the houses, the developed algorithms cannot have the training data set in the houses. For this reason, a NILM model with an unsupervised learning method can be used for load disaggregation in residential buildings.

7.2. Future work

Despite recent advances in the NILM, it still faces many challenges that limit its true potential. In order to reach NILM to its true potential, researchers can study the following topics in the future. A single NILM approach may be insufficient when devices are operating simultaneously, with high ripples. The hybrid NILM approach will be more effective to eliminate false events, detect events correctly, take advantage of many device features, and classify datasets more clearly. For example, the method to be developed for event detection can not only perform derivative analysis but also filter analysis. Thus, derivative analysis removes false events in the same device transient, filtering analysis eliminates false detected events due to fluctuation, and event detection is performed with high accuracy.

The circuit structure of the devices in the homes is constantly changing and it is inevitable that the devices will contain more power electronic circuits (eg:air conditioners with inverter) in the near future. In power electronics circuits, distortions occur in current and voltage signals resulting from switching and include serious harmonics. NILM models to be developed should be in a structure that can respond to these systems.

Almost all of the studies on NILM in the literature cover load disaggregation in houses. However, the widespread of energy management systems developed for the efficient use and savings of energy, and preliminary fault detection analyzes for device safety have gained importance. Since NILM provides information to both systems, it should be expanded not only in residential buildings but also in commercial and public buildings.

8. Conclusion

Equipping the entire home with sensors to collect the power consumption data of each device for load monitoring in residential and commercial buildings is costly and complex. Therefore, NILM methods that perform load disaggregation by measuring from a single point have been widely used in the literature. In these studies, the devices were handled in four different categories. Some device types (ON/OFF, FSM) are often preferred because they are easier to disaggregate. On the other hand, CVD types in residential and business areas can reduce the performance of the methods proposed for NILM in practice.

Device features utilized in the literature can be classified as steady-state, transient state, and non-traditional. Steady-state features require higher sampling frequencies, while transient state features are used at both sampling frequencies and low sampling frequencies. In addition, it can be said that some features are more successful in disaggregate certain devices. However, no feature extraction method that could be successful for all device types was encountered in the studies reviewed. On the other hand, more than one feature extraction method was used together to be more successful in the load identification.

Supervised, unsupervised, and semisupervised learning methods are proposed in NILM for load definition. Although supervised learning methods are used in most of these approaches, unsupervised learning stands out as the most appropriate approach for NILM since it does not require consumer intervention. However, recently, semisupervised learning methods have been attracted researchers' interest in this realm.

References

- [1] Chua K, Chou S, Yang W, Yan J. Achieving better energy-efficient air conditioning – a review of technologies and strategies. *Applied Energy* 2013; 104: 87-104. doi: 10.1016/j.apenergy.2012.10.037

- [2] Fischer C. Feedback on household electricity consumption: a tool for saving energy. *Energy Efficiency* 2008; 1: 79-104. doi: 10.1007/s12053-008-9009-7
- [3] Karjalainen S. Consumer preferences for feedback on household electricity consumption. *Energy and Buildings* 2011; 43: 458 – 467. doi: 10.1016/j.enbuild.2010.10.010
- [4] Peschiera G, Taylor JE, Siegel JA. Response–relapse patterns of building occupant electricity consumption following exposure to personal, contextualized and occupant peer network utilization data. *Energy and Buildings* 2010; 42: 1329 – 1336. doi: 10.1016/j.enbuild.2010.03.001
- [5] Selamogullari US, Elma O. A smart transformer application for voltage-controlled home energy management system. *Journal of the Faculty of Engineering and Architecture of Gazi University* 2018; 33: 1543 – 1556. doi: 10.17341/gazimmfd.416450
- [6] Pau G, Collotta M, Ruano A, Qin J. Smart home energy management. *Energies* 2017; 10: 39970-39974. doi: 10.3390/en10030382
- [7] Sundramoorthy V, Cooper G, Linge N, Liu Q. Domesticating energy-monitoring systems: Challenges and design concerns. *IEEE Pervasive Computing* 2011; 10: 20-27. doi: 10.1109/MPRV.2010.73
- [8] Berges M, Goldman E, Matthews HS, Soibelman L, Anderson K. User-centered nonintrusive electricity load monitoring for residential buildings. *Journal of Computing in Civil Engineering* 2011; 25: 471-480. doi: 10.1111/j.1530-9290.2010.00280.x
- [9] Wong Y, Sekercioglu A, Drummond T, Wong V. Recent approaches to non-intrusive load monitoring techniques in residential settings. *IEEE Symposium on Computational Intelligence Applications in Smart Grid (CIASG) 2013*; :73-79. doi:10.1109/CIASG.2013.6611501
- [10] Lu T, Xu Z, Huang B. An Event-Based Nonintrusive Load Monitoring Approach: Using the Simplified Viterbi Algorithm. *IEEE Pervasive Computing* 2017; 16: 54-61. doi: 10.1109/MPRV.2017.3971125
- [11] Kim H, Marwah M, Arlitt MF, Lyon G, Han J. Unsupervised Disaggregation of Low Frequency Power Measurements. *Proc. SIAM Conf. Data Mining* 2011; 11: 747-758. doi: 10.1137/1.9781611972818.64
- [12] Kolter J, Jaakkola T. Approximate inference in additive factorial HMMs with application to energy disaggregation. In: *International Conference on Artificial Intelligence and Statistics* 2012; 22: 1472-1482.
- [13] Parson O, Ghosh S, Weal M, Rogers A. Non-intrusive load monitoring using prior models of general appliance types. In *Proceeding of the twenty-Sixth AAAI Conference on Artificial Intelligence (AAAI-12)*, Toronto, Canada; 2012.
- [14] Zoha A, Gluhak A, Imran MA, Rajasegarar S. Nonintrusive Load Monitoring approaches for disaggregated energy sensing: A survey. *Sensors* 2012; 12: 16838–16866. doi: 10.3390/s121216838
- [15] Hart GW. Nonintrusive appliance load monitoring. *Proceedings of the IEEE* 1992; 80: 1870–1891. doi: 10.1109/5.192069
- [16] Ruano A, Hernandez A, Urena J, Ruano M, Garcia J. NILM Techniques for Intelligent Home Energy Management and Ambient Assisted Living: A Review. *Energies* 2019; 12: 2203. doi: 10.3390/en12112203
- [17] Zeifman M, Roth K. Nonintrusive appliance load monitoring: Review and Outlook. *IEEE Transactions on Consumer Electronics* 2011; 57: 76-84. doi: 10.1109/TCE.2011.5735484
- [18] He D, Du L, Yang Y, Harley R, Habetler T. Front-end electronic circuit topology analysis for model-driven classification and monitoring of appliance loads in smart buildings. *IEEE Trans. Smart Grid* 2012; 3 (4): 2286-2293. doi:10.1109/TSG.2012.2219327
- [19] Nait Meziane M, Ravier P, Lamarque G, Le Bunete J, Raingeaud Y. High accuracy event detection for nonintrusive load monitoring. In: *IEEE International Conference on Acoustics, Speech and Signal Processing (ICASSP)*, New Orleans, LA, USA; 2017. pp. 2452–2456.
- [20] Anderson KD, Berges ME, Oceaneu A, Benitez D, Moura JM. Event detection for Non Intrusive load monitoring. In: *IECON Proceedings (Industrial Electronics Conference)*; Montreal, QC, Canada; 2012. pp. 3312– 3317.

- [21] Hart, G.W. Prototype Nonintrusive Appliance Load Monitor. Technical Report Progress Report. MIT Energy Laboratory 1985.
- [22] Sultanem, F. Using appliance signatures for monitoring residential loads at meter panel level. *IEEE Transactions on Power Delivery* 1991; 6: 1380–1385. doi: 10.1109/61.97667
- [23] Liang J, Ng SK, Kendall G, Cheng JW. Load signature study part I: Basic concept, structure, and methodology. *IEEE Transactions on Power Delivery* 2009; 25 (6): 551-560. doi: 10.1109/TPWRD.2009.2033799
- [24] Weiss M, Helfenstein A, Mattern F, Staake T. Leveraging smart meter data to recognize home appliances. In: *IEEE International Conference on Pervasive Computing and Communications*; Lugano, Switzerland; 2012. pp. 190–197.
- [25] Meehan P, McArdle C, Daniels S. An efficient, scalable time-frequency method for tracking energy usage of domestic appliances using a two-step classification algorithm. *Energies* 2014; 7; 7041– 7066. doi: 10.3390/en7117041
- [26] Dong M. Decomposition Techniques for Power System Load Analysis. PhD, University of Alberta, Department of Electrical and Computer Engineering, Alberta, Canada, 2013.
- [27] Lu M, Li Z. A hybrid event detection approach for nonintrusive load monitoring. *IEEE Transactions on Smart Grid* 2020; 11: 528–540. doi: 10.1109/TSG.2019.2924862
- [28] Luo D, Norford L, Shaw S, Leeb SB, Danks R et al. Monitoring hvac equipment electrical loads from a centralized location methods and field test results. *ASHRAE Transactions* 2002; 108: 841–857.
- [29] Jin Y, Tebekaemi E, Berges M, Soibelman L. Robust adaptive event detection in non-intrusive load monitoring for energy aware smart facilities. In: *IEEE International Conference on Acoustics, Speech and Signal Processing (ICASSP)*; Prague, Czech Republic; 2011. pp. 4340–4343.
- [30] Nguyen K, Dekneuvél E, Nicoll B, Zammit O, Van C et al. Event detection and disaggregation algorithms for nialm system. In: *International Workshop on Non-Intrusive Load Monitoring (NILM)*; 2014.
- [31] Zhu Z, Zhang S, Wei Z, Yin B, Huang X. A novel CUSUM-based approach for event detection in smart metering. In: *IOP Conference Series: Materials Science and Engineering*; Prague, Czech Republic; 2018.
- [32] Wild B, Barsim KS, Yang B. A new unsupervised event detector for non-intrusive load monitoring. In: *IEEE Global Conference on Signal and Information Processing (GlobalSIP)*; Orlando, FL, USA; 2015. pp. 73-77.
- [33] Pereira L. Developing and evaluating a probabilistic event detector for non-intrusive load monitoring. In: *Sustainable Internet and ICT for Sustainability (SustainIT)*; Funchal, Portugal; 2017. pp. 1-10.
- [34] Gonzalez MEB. A Framework for Enabling EnergyAware Facilities through Minimally-Intrusive Approaches. PhD, Carnegie Mellon University, Schenley Park Pittsburgh, PA United States, 2010.
- [35] Pereira L, Quintal F, Goncalves R, Nunes N. Sustdata: A public dataset for ict4s electric energy research. In: *International Conference on ICT for Sustainability*; Stockholm, Sweden; 2014.
- [36] Norford LK, Leeb SB. Non-intrusive electrical load monitoring in commercial buildings based on steady-state and transient load-detection algorithms. *Energy and Buildings* 1996; 24; 51–64. doi: 10.1016/0378-7788(95)00958-2
- [37] Alcalá JM, Ureña J, Hernández A. Event-based detector for non-intrusive load monitoring based on the Hilbert Transform. In: *IEEE International Conference on Emerging Technologies and Factory Automation*; Barcelona, Spain; 2014. pp. 14-17.
- [38] Streubel R, Yang B. Identification of electrical appliances via analysis of power consumption. In: *International Universities Power Engineering Conference (UPEC)*; Barcelona, Spain; 2012. pp. 1-6.
- [39] Barsim KS, Streubel R, Yang B. Unsupervised adaptive event detection for building-level energy disaggregation. In: *Power and Energy Student Summit (PESS)*; Stuttgart, Germany; 2014.
- [40] Zheng Z, Chen H, Luo X. A supervised event-based nonintrusive load monitoring for non-linear appliances. *Sustainability* 2018; 10. doi: 10.3390/su10041001

- [41] Armel C, Gupta A, Shrimali G, Albert A. Is disaggregation the holy grail of energy efficiency? The case of electricity. *Energy Policy* 2013; 52: 213–234. doi:10.1016/j.enpol.2012.08.062
- [42] Chang HH. Non-intrusive demand monitoring and load identification for energy management systems based on transient feature analyses. *Energies* 2012; 5: 4569–4589. doi: 10.3390/en5114569
- [43] Duarte C, Delmar P, Goossen KW, Barner K, Gomez-Luna E. Non-intrusive load monitoring based on switching voltage transients and wavelet transforms. In: *Future of Instrumentation International Workshop (FIIW)*; Gatlinburg, TN, USA; 2012.
- [44] Farinaccio L, Zmeureanu R. Using a pattern recognition approach to disaggregate the total electricity consumption in a house into the major end-uses. *Energy and Buildings* 1999; 30: 245–259. doi: 10.1016/S0378-7788(99)00007-9
- [45] Marceau M, Zmeureanu R. Nonintrusive load disaggregation computer program to estimate the energy consumption of major end uses in residential buildings. *Energy Conversion and Management* 2000; 41: 1389–1403. doi: 10.1016/S0196-8904(99)00173-9
- [46] Powers JT, Margossian B, Smith BA. Using a rule-based algorithm to disaggregate end-use load profiles from premise-level data. *IEEE Computer Applications in Power* 1991; 4: 42–47. doi: 10.1109/67.75875
- [47] Belley C, Gaboury S, Bouchard B, Bouzouane A. An efficient and inexpensive method for activity recognition within a smart home based on load signatures of appliances. *Pervasive and Mobile Computing* 2014; 12: 58-78. doi: 10.1016/j.pmcj.2013.02.002
- [48] Nguyen M, Alshareef S, Gilani A, Morsi WG. A novel feature extraction and classification algorithm based on power components using single-point monitoring for NILM. In: *Canadian Conference on Electrical and Computer Engineering*; Halifax, NS, Canada; 2015. pp. 37-40.
- [49] Srinivasan D, Ng WS, Liew AC. Neural-network-based signature recognition for harmonic source identification. *IEEE Transactions on Power Delivery* 2006; 21: 398-405. doi: 10.1109/TPWRD.2005.852370
- [50] Najmeddine H, El Khamlichi DK, Pasquier C, Faure C, Kerroum K et al. State of art on load monitoring methods. In: *IEEE 2nd International Power and Energy Conference*; Johor Bahru, Malaysia; 2008. pp. 1256–1258.
- [51] Dong M, Meira PC, Xu W, Chung CY. Non-intrusive signature extraction for major residential loads. *IEEE Transactions on Smart Grid* 2013; 4: 1421-1430. doi: 10.1109/TSG.2013.2245926
- [52] Chang HH, Lee MC, Lee WJ, Chien CL, Chen N. Feature Extraction-Based Hellinger Distance Algorithm for Nonintrusive Aging Load Identification in Residential Buildings. *IEEE Transactions on Industry Applications* 2016; 52: 2031–2039. doi: 10.1109/IAS.2015.7356778
- [53] Ruzzelli A, Nicolas C, Schoofs A, O'Hare G. Real-Time Recognition and Profiling of Appliances through a Single Electricity Sensor. *IEEE SECON* 2010. pp. 1 – 9. doi: 10.1109/SECON.2010.5508244
- [54] Figueiredo M, De Almeida A, Ribeiro B. Home electrical signal disaggregation for non-intrusive load monitoring (NILM) systems. *Neurocomputing* 2012; 96: 66-73. doi: 10.1016/j.neucom.2011.10.037
- [55] Lam HY, Fung GS, Lee WK. A novel method to construct taxonomy electrical appliances based on load signatures. *IEEE Transactions on Consumer Electronics* 2014; 53: 653-660. doi: 10.1109/TCE.2007.381742
- [56] Hassan T, Javed F, Arshad N. An empirical investigation of V-I trajectory based load signatures for non-intrusive load monitoring. *IEEE Transactions on Smart Grid* 2014; 5: 870-878. doi: 10.1109/TSG.2013.2271282
- [57] Wang AL, Chen BX, Wang CG, Hua DD. Nonintrusive load monitoring algorithm based on features of V-I trajectory. *Electric Power Systems Research* 2018; 157: 134-144. doi: 10.1016/j.epsr.2017.12.012
- [58] Baets LD, Ruysinck J, Develder C, Dhaene T, Deschrijver D. Appliance classification using VI trajectories and convolutional neural networks. *Energy and Buildings* 2018; 158: 32-36. doi: 10.1016/j.enbuild.2017.09.087
- [59] Teshome DF, Huang TD, Member KLS. Distinctive Load Feature Extraction Based on Fryze's Time-Domain Power Theory. *IEEE Power and Energy Technology Systems Journal* 2016; 3: 60-70. doi: 10.1109/JPETS.2016.2559507

- [60] Eckmann JP, Kamphorst S, Ruelle D. Recurrence plots of dynamical systems. *Europhysics Letters* 1987; 4: 973–977.
- [61] Popescu F, Enache F, Vizitiu IC, Ciotîrnae P. Recurrence plot analysis for characterization of appliance load signature. In: *International Conference on Communications (COMM)*; Bucharest, Romania; 2014. pp. 1-4.
- [62] Faustine A, Pereira L. Improved appliance classification in non-intrusive load monitoring using weighted recurrence graph and convolutional neural networks. *Energies* 2020; 13. doi: 10.3390/en13133374
- [63] Faustine A, Pereira L, Klemenjak C. Adaptive weighted recurrence graphs for appliance recognition in non-intrusive load monitoring. *IEEE Transactions on Smart Grid* 2021; 12: 398-406. doi: 10.1109/TSG.2020.3010621
- [64] Leeb SB, Kirtley JL. A multiscale transient event detector for nonintrusive load monitoring. In: *19th Annual Conference of IEEE Industrial Electronics*; Maui, HI, USA; 1993. pp. 354-359.
- [65] Leeb SB, LeVan MS, Kirtley Jr JL, Sweeney JP. Development and validation of a transient event detector. *AMP Journal of Technology* 1993; 3: 69-74. doi: 10.1.1.203.5538
- [66] Cole AI, Albicki A. Data extraction for effective nonintrusive identification of residential power loads. In: *IEEE Instrumentation and Measurement Technology Conference*; St. Paul, MN, USA; 1998. pp. 812-815.
- [67] Cole AI, Albicki, A. Algorithm for nonintrusive identification of residential appliances. In: *IEEE International Symposium on Circuits and Systems (ISCAS)*; Monterey, CA, USA; 1998. pp. 338-341.
- [68] Shaw SR, Leeb SB, Norford LK, Cox RW. Nonintrusive load monitoring and diagnostics in power systems. *IEEE Transactions on Instrumentation and Measurement* 2008; 57: 1445-1454. doi: 10.1109/TIM.2008.917179
- [69] Chan WL, So ATP, Lai LL. Harmonics load signature recognition by wavelets transforms. In: *International Conference on Electric Utility Deregulation and Restructuring and Power Technologies*; London, UK; 2000. pp. 666-671.
- [70] Chang H, Chen K, Tsai Y, Lee W. A New Measurement Method for Power Signatures of Nonintrusive Demand Monitoring and Load Identification. *IEEE Transactions on Industry Applications* 2012; 48: 764-771. doi: 10.1109/TIA.2011.2180497
- [71] Su Y, Lian K, Chang H. Feature Selection of Non-intrusive Load Monitoring System Using STFT and Wavelet Transform. In: *IEEE 8th International Conference on e-Business Engineering*; Beijing, China; 2011. pp. 293-298.
- [72] Gray M, Morsi WG. Application of wavelet-based classification in non-intrusive load monitoring. In: *Canadian Conference on Electrical and Computer Engineering*; Halifax, NS, Canada; 2015. pp. 41-45.
- [73] Kim H, Marwah M, Arlitt M, Lyon G, Han J. Unsupervised disaggregation of low frequency power measurements. In: *11th SIAM International Conference on Data Mining*; Mesa, Arizona, USA; 2011. pp. 747-758.
- [74] Zeifman M. Disaggregation of home energy display data using probabilistic approach. *IEEE Transactions on Consumer Electronics* 2012; 58: 23-31. doi: 10.1109/TCE.2012.6170051
- [75] Koutitas GC, Tassioulas L. Low Cost Disaggregation of Smart Meter Sensor Data. *IEEE Sensors Journal* 2016; 16. doi: 10.1109/JSEN.2015.2501422
- [76] Wang Z, Zheng G. Residential appliances identification and monitoring by a nonintrusive method. *IEEE Transactions on Smart Grid* 2012; 3: 80-92. doi: 10.1109/TSG.2011.2163950
- [77] Himeur Y, Alsalemi A, Bensaali, F, Amira A. Smart non-intrusive appliance identification using a novel local power histogramming descriptor with an improved k- nearest neighbors classifier. *Sustainable Cities and Society* 2021; 67. doi: 10.1016/j.scs.2021.102764
- [78] Chowdhury D, Hasan M, Rahman Khan MZ. Statistical features extraction from current envelopes for non-intrusive appliance load monitoring. In: *2020 SoutheastCon*; Raleigh, NC, USA; 2020. pp. 1-5.
- [79] Chang HH, Lin CL. A new method for load identification of nonintrusive energy management system in smart home. In: *IEEE 7th International Conference on E-Business Engineering*; Shanghai, China; 2010. pp.351-357.

- [80] Chang H, Lin L, Chen N, Lee W. Particle-swarm optimization-based nonintrusive demand monitoring and load identification in smart meters. *IEEE Transactions on Industry Applications* 2013; 49: 2229–2236 doi: 10.1109/TIA.2013.2258875
- [81] Gao J, Giri S, Kara E, Bergés M. Plaid: A public dataset of high-resolution electrical appliance measurements for load identification research. *Proceedings of the 1st ACM Conference on Embedded Systems for Energy-Efficient Buildings* 2014; 198–199. doi: 10.1145/2674061.2675032
- [82] Kahl M, Haq A, Kriechbaumer T, Jacobsen HA. Whited- a worldwide household and industry transient energy data set. In: *International Workshop on Non-Intrusive Load Monitoring*; 2016.
- [83] Dongsong Z, Qi M. A load identification algorithm based on SVM. In: *First International Conference on Electronics Instrumentation and Information Systems (EIS)*; Harbin, China; 2017. pp. 1-5.
- [84] Laughman C, Lee K, Cox R, Shaw S, Leeb S et al. Power signature analysis. *IEEE Power and Energy Magazine* 2003; 1: 56-63. doi: 10.1109/MPAE.2003.1192027
- [85] Basu K, Debusschere V, Bacha S, Maulik U, Bondyopadhyay S. Nonintrusive load monitoring: A temporal multilabel classification approach. *IEEE Transactions on Industrial Informatics* 2015; 11: 262-270. doi: 10.1109/TII.2014.2361288
- [86] Kaliberda M, Lytvynenko L, Pogarsky S. Method of singular integral equations in diffraction by semi-infinite grating: H-polarization case. *Turkish Journal of Electrical Engineering & Computer Sciences* 2017; 25 (6): 4496-4509. doi: 10.3906/elk-1703-170
- [87] Zhang X, Luan Z, Zhang Z. Steady state load decomposition method combining template matching with k-nearest neighbor algorithms. In: *International Conference on Smart Grid and Clean Energy Technologies*; Kajang, Malaysia; 2018. pp. 250–254.
- [88] Mueller JA, Kimball JW. Accurate Energy Use Estimation for Nonintrusive Load Monitoring in Systems of Known Devices. *IEEE Transactions on Smart Grid* 2018; 9: 2797–2808. doi: 10.1109/TSG.2016.2620120
- [89] Ridi A, Gisler C, Hennebert J. Appliance and state recognition using Hidden Markov Models. In: *International Conference on Data Science and Advanced Analytics (DSAA)*; Shanghai, China; 2014. pp. 270–276.
- [90] Berges M, Goldman E, Matthews HS. Learning systems for electric consumption of buildings. In: *Proceedings of the 2009 ASCE International Workshop on Computing in Civil Engineering*; 2009. pp. 1-10.
- [91] Liao J, Elafoudi G, Stankovic L, Stankovic V. Nonintrusive appliance load monitoring using low-resolution smart meter data. In: *IEEE International Conference on Smart Grid Communications*; Venice, Italy; 2014. pp. 535-540.
- [92] Stankovic L, Stankovic V, Liao J, Wilson C. Measuring the energy intensity of domestic activities from smart meter data. *Applied Energy* 2016; 183: 1565-1580. doi: 10.1016/j.apenergy.2016.09.087
- [93] Guedes JD, Ferreira DD, Barbosa BH. A non-intrusive approach to classify electrical appliances based on higher-order statistics and genetic algorithm. *Electric Power Systems Research* 2016; 140: 65-69. doi: 10.1016/j.epsr.2016.06.042
- [94] Liu Y, Wang X, Zhao L, Liu Y. Admittance-based load signature construction for non-intrusive appliance load monitoring. *Energy and Buildings* 2018; 171: 209-219. doi: 10.1016/j.enbuild.2018.04.049
- [95] De Baets L, Dhaene T, Deschrijver D, Develder C, Berges M. VI-Based Appliance Classification Using Aggregated Power Consumption Data. In: *IEEE International Conference on Smart Computing (SMARTCOMP)*; Taormina, Italy; 2014. pp. 179-186.
- [96] Meehan P, McArdle C, Daniels S. An Efficient, Scalable Time-Frequency Method for Tracking Energy Usage of Domestic Appliances Using a Two-Step Classification Algorithm. *Energies* 2014; 7: 7041-7066. doi: 10.3390/en7117041
- [97] Yang C, Soh C, Yap V. A systematic approach in appliance disaggregation using k-nearest neighbours and naive Bayes classifiers for energy efficiency. *Energy Efficiency* 2018; 11. doi:10.1007/s12053-017-9561-0.

- [98] Marchiori A, Hakkarinen D, Han Q, Earle L. Circuit-Level Load Monitoring for Household Energy Management. *Pervasive Computing* 2011; 10: 40 – 48. doi: 10.1109/MPRV.2010.72
- [99] Hock D, Kappes M, Ghita B. Non-Intrusive Appliance Load Monitoring using Genetic Algorithms. *IOP Conference Series: Materials Science and Engineering* 2018; 366. doi: 10.1088/1757-899X/366/1/012003
- [100] Egarter D, Sobe A, Elmenreich W. Evolving non-intrusive load monitoring. *Applications of Evolutionary Computation* 2013; 7835. doi: 10.1007/978-3-642-37192-9-19
- [101] Suzuki K, Inagaki S, Suzuki T, Nakamura H, Ito K. Nonintrusive appliance load monitoring based on integer programming. In: *SICE Annual Conference*; Tokyo, Japan; 2008. pp. 2742–2747.
- [102] Bhotto MZA, Makonin S, Bajić IV. Load disaggregation based on aided linear integer programming. *IEEE Transactions on Circuits and Systems II: Express Briefs* 2017; 64: 792-796. doi: 10.1109/TCSII.2016.2603479
- [103] De Baets L, Ruyssinck J, Develder C, Dhaene T, Deschrijver D. On the Bayesian optimization and robustness of event detection methods in NILM. *Energy and Buildings* 2017; 145: 57-66. doi: 10.1016/j.enbuild.2017.03.061
- [104] Machlev R, Belikov J, Beck Y, Levron Y. MO-NILM: A multi-objective evolutionary algorithm for NILM classification. *Energy and Buildings* 2019; 199: 134-144. doi: 10.1016/j.enbuild.2019.06.046
- [105] Gonçalves H, Oceanu A, Bergés M, Fan RH. Unsupervised disaggregation of appliances using aggregated consumption data. In: *KDD 2011 Workshop on Data Mining Applications for Sustainability*; 2011. pp. 21-24.
- [106] Liu Q, Kamoto, KM, Liu X, Sun M, Linge N. Low Complexity Non-Intrusive Load Monitoring Using Unsupervised Learning and Generalized Appliance Models. *IEEE Transactions on Consumer Electronics* 2019; 65: 28-37. doi: 10.1109/TCE.2019.2891160
- [107] Ghahramani Z, Jordan MI. Factorial Hidden Markov Models. *Machine Learning* 1997; 245-273. doi: 10.1023/A:1007425814087
- [108] Aiad M, Lee PH. Unsupervised approach for load disaggregation with devices interactions. *Energy and Buildings* 2016; 116; 96-103. doi: 10.1016/j.enbuild.2015.12.043
- [109] Zhao B, Stankovic L, Stankovic V. On a Training-Less Solution for Non-Intrusive Appliance Load Monitoring Using Graph Signal Processing. *IEEE Access* 2016; 4: 1784–1799. doi: 10.1109/ACCESS.2016.2557460
- [110] He K, Stankovic L, Liao J, Stankovic V. Non-intrusive load disaggregation using graph signal processing. *IEEE Transactions on Smart Grid* 2018; 9: 1739–1747. doi: 10.1109/TSG.2016.2598872
- [111] Iwayemi A, Zhou C. SARAA: Semi-Supervised Learning for Automated Residential Appliance Annotation. *IEEE Transactions on Smart Grid* 2017; 8: 779–786. doi: 10.1109/TSG.2015.2498642
- [112] Gillis J, Morsi WG. Non-intrusive load monitoring using orthogonal wavelet analysis. In: *Canadian Conference on Electrical and Computer Engineering*; Vancouver, BC, Canada; 2016. pp. 1-5.
- [113] Renaux D, Pottker F, Ancelmo H, Lazzaretti A, Erig LC, Linhares R et al. A Dataset for Non-Intrusive Load Monitoring: Design and Implementation. *Energies* 2020; 20: 1-35. doi: 110.3390/en13205371
- [114] Klemenjak C, Kovatsch C, Herold Manuel, Elmenreich W. A synthetic energy dataset for non-intrusive load monitoring in households. *Scientific Data* 2020. doi: 10.1038/s41597-020-0434-6
- [115] Kolter JZ, Matthew JJ. REDD: A public data set for energy disaggregation research. *Artif. Intell.* 2011; 25.
- [116] Anderson K, Oceanu A, Carlson DR, Rowe A, Bergés M. BLUED: A fully labeled public dataset for event-based non-intrusive load monitoring research In: *Proceedings of the 2nd KDD Workshop on Data Mining Applications in Sustainability (SustKDD)*; ACM, Beijing, China; 2012. pp. 1-5.
- [117] Reinhardt A, Baumann P, Burgstahler D, Hollick M, Chonov H et al. On the accuracy of appliance identification based on distributed load metering data. In: *2012 Sustainable Internet and ICT for Sustainability (SustainIT)* 2012. pp. 1-9.

- [118] Monacchi A, Egarter D, Elmenreich W, D'Alessandro S, Tonello A. An energy consumption dataset of households in Italy and Austria. In: 2014 IEEE International Conference on Smart Grid Communications (SmartGridComm); 2014. pp. 511–516.
- [119] Kelly J, Knottenbelt W. The UK-DALE dataset, domestic appliance-level electricity demand and whole-house demand from five UK homes. In: *Scientific Data* 2015; 2: doi: 10.1038/sdata.2015.7
- [120] Picon T, Meziane MN, Ravier P, Lamarque G, Novello C et al. COOLL: controlled on/off loads library, a public dataset of high-sampled electrical signals for appliance identification; 2016.
- [121] Ribeiro M, Pereira L, Quintal F, Nunes N. SustDataED: A Public Dataset for Electric Energy Disaggregation Research. In *Proceedings of the 2016 ICT for Sustainability*; Amsterdam, Netherlands; 2016; pp. 244–245.
- [122] Kriechbaumer T, Jacobsen HA. BLOND, a building-level office environment dataset of typical electrical appliances. *Scientific Data* 2018; 5: doi: 10.1038/sdata.2018.48
- [123] Xinmei Y, Peng H, Yao D, Rosemary A, Vandana R et al. Residential Electrical Load Monitoring and Modeling – State of the Art and Future Trends for Smart Homes and Grids. *Electric Power Components and Systems* 2020; 48: 1-19. doi:10.1080/15325008.2020.1834019
- [124] Pereira L, Nunes N. Performance evaluation in non-intrusive load monitoring: Datasets, metrics, and tools-A review. *Wiley Interdisciplinary Reviews: Data Mining and Knowledge Discovery* 2018; 8. doi:10.1002/widm.1265
- [125] Chang HH, Lee MC, Lee WJ, Chien CL, Chen N. Feature Extraction-Based Hellinger Distance Algorithm for Nonintrusive Aging Load Identification in Residential Buildings. *IEEE Transactions on Industry Applications* 2016; 52: 2031–2039. doi: 10.1109/IAS.2015.7356778
- [126] Faustine A, Mvungi NH, Kaijage SF, Kisangiri M. A Survey on Non-Intrusive Load Monitoring Methodies and Techniques for Energy Disaggregation Problem. *ArXiv* 2017; abs/1703.00785.
- [127] Altrabalsi H, Stankovic V, Liao J, Stankovic L. Low-complexity energy disaggregation using appliance load modelling. *AIMS Energy* 2016; 4 (1): 1-21; doi: 10.3934/energy.2016.1.1
- [128] Makonin S, Popowich F. Nonintrusive load monitoring (NILM) performance evaluation. *Springer Energy Efficiency* 2014; 8 (4): 809-814; doi: 10.1007/s12053-014-9306-2
- [129] Liang J, Ng SK, Kendall G, Cheng JW. Load signature study part I: Basic concept, structure, and methodology. *IEEE Transactions on Power Delivery* 2009; 25 (6): 551-560. doi: 10.1109/TPWRD.2009.2033799
- [130] Ziwei X, Wenjie G, Jiaqi Y, Ying Z, Cheng F. Cooling Load Disaggregation Using a NILM Method Based on Random Forest for Smart Buildings. *Sustainable Cities and Society* 2021; 74: 103202; doi: 10.1016/j.scs.2021.103202
- [131] Mueller JA, Kimball JW. Accurate Energy Use Estimation for Nonintrusive Load Monitoring in Systems of Known Devices. *IEEE Transactions on Smart Grid* 2018; 9: 2797–2808. doi: 10.1109/TSG.2016.2620120
- [132] Qi L, Kondwani K, Xiaodong L, Mingxu S, Nigel L. Low-Complexity Non-Intrusive Load Monitoring Using Unsupervised Learning and Generalized Appliance Models. *IEEE Transactions on Consumer Electronics* 2019; 1 (1): 1-1. doi: 10.1109/TCE.2019.2891160
- [133] Desai S, Alhadad R, Mahmood A, Chilamkurti N, Rho S. Multi-State Energy Classifier to Evaluate the Performance of the NILM Algorithm. *Sensors* 2019; 19 (23): 5236 doi:10.3390/s19235236