

**VII. INTERNATIONAL HALICH CONGRESS ON MULTIDISCIPLINARY
SCIENTIFIC RESEARCH**

JANUARY 23-25, 2024, ISTANBUL

THE BOOK OF FULL TEXTS



**Edited by
Prof. Dr. Muhittin ELIAÇIK
Gulnaz GAFUROVA**

ISBN: 978-625-367-639-1

**VII. INTERNATIONAL HALICH CONGRESS ON
MULTIDISCIPLINARY SCIENTIFIC RESEARCH**

January 23-25, 2024 / Istanbul, Türkiye

THE BOOK OF FULL TEXTS

Edited by

Prof. Dr. Muhittin ELİAÇIK

Gulnaz GAFUROVA

All rights of this book belong to İKSAD Publishing House.

Without permission can't be duplicated or copied.

Authors of chapters are responsible both ethically and juridically.

Issued: 15.02.2024

ISBN: 978-625-367-639-1

CONGRESS ID

**VII. INTERNATIONAL HALICH CONGRESS ON
MULTIDISCIPLINARY SCIENTIFIC RESEARCH**

DATE AND PLACE

January 23-25, 2024/ Istanbul, Türkiye

CONGRESS CHAIR

Prof. Dr. Muhittin ELİAÇIK- Kırıkkale University

PRESENTATION

Online Presentation

PARTICIPANTS COUNTRIES

**TÜRKİYE, AZERBAIJAN, KAZAKHSTAN, INDONESIA,
PAKISTAN, NIGERIA, CANADA, SERBIA, CYPRUS, ALGERIA,
INDIA, MALAYSIA, MOROCCO, UKRAINE, MACEDONIA,
VIETNAM, BULGARIA, MONGOLIA, GEORGIA, KOSOVO,
MOLDOVA, IRAQ, BRAZIL, ROMANIA, PHILIPPINES, UNITED
ARAB EMIRATES, RUSSIA, SOUTH AFRICA, ALBANIA,
HUNGARY, SPAIN, IRAN**

TOTAL NUMBER OF PAPERS 394

THE NUMBER OF PAPERS FROM TÜRKİYE 194

OTHER COUNTRIES 200

NUMBER OF REJECTED PAPERS 30

EVALUATION PROCESS

All applications have undergone a double-blind peer review process

SCIENTIFIC & REVIEW COMMITTEE

Prof. Dr. Hacer HÜSEYNOVA- Azerbaijan State Pedagogical University

**Assoc. Prof. Dr. Gulbaxar Tavaldieva- Tashkent Chemical Technological
Institute**

Assoc. Prof. Dr. Fatma İNCE- Inonu University

Assoc. Prof. Dr. İryna Dryga- National Academy of Sciences

Assoc. Prof. Dr. Mehmet Gökhan GENEL- Yalova University

Assoc. Prof. Dr. Saime GÜZEL- Bursa Uludag University

Assoc. Prof. Dr. Varol KOÇ- Ondokuz Mayıs University

**Assoc. Prof. Dr. H. Burçin HENDEN ŞOLT- Zonguldak Bulent Ecevit
University**

Assoc. Prof. Dr. F. Gül KOÇSOY- Fırat University

Asst. Prof. Dr. Leyla BEKENSİR- Ankara University

Asst. Prof. Dr. Muhammet Zeki ÖZYURT- Sakarya University

Dr. Terane NAGIYEVA - Azerbaijan State Pedagogical University

Asst. Prof. Dr. Ömer KASIM- Kutahya Dumlupınar University

Asst. Prof. Dr. Ramazan ARITÜRK- İstanbul Sabahattin Zaim University

Dr. Damejan SADYKOVA- Kazak Kızlar Pedogoji Üniversitesi

Dr. Mariam S. OLSSON- Lebanise University

PHOTO GALLERY

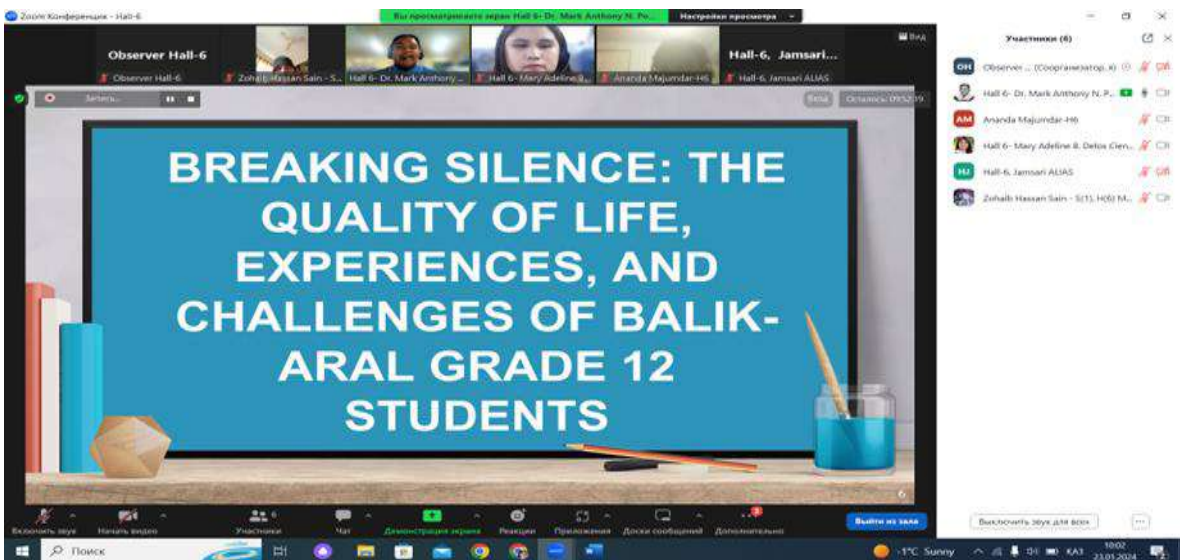
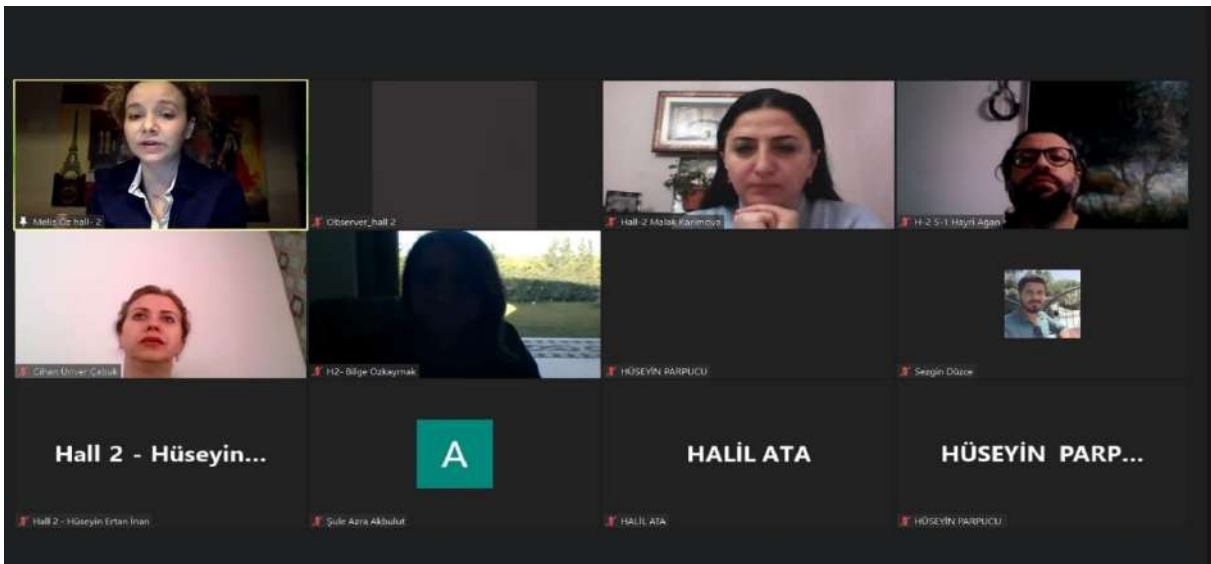
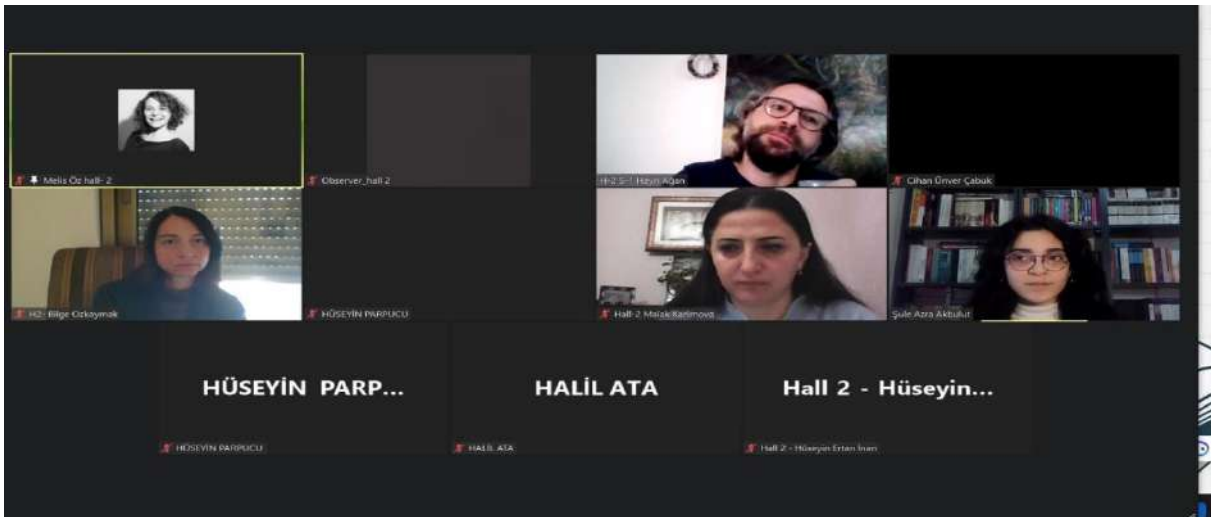

PHOTO GALLERY

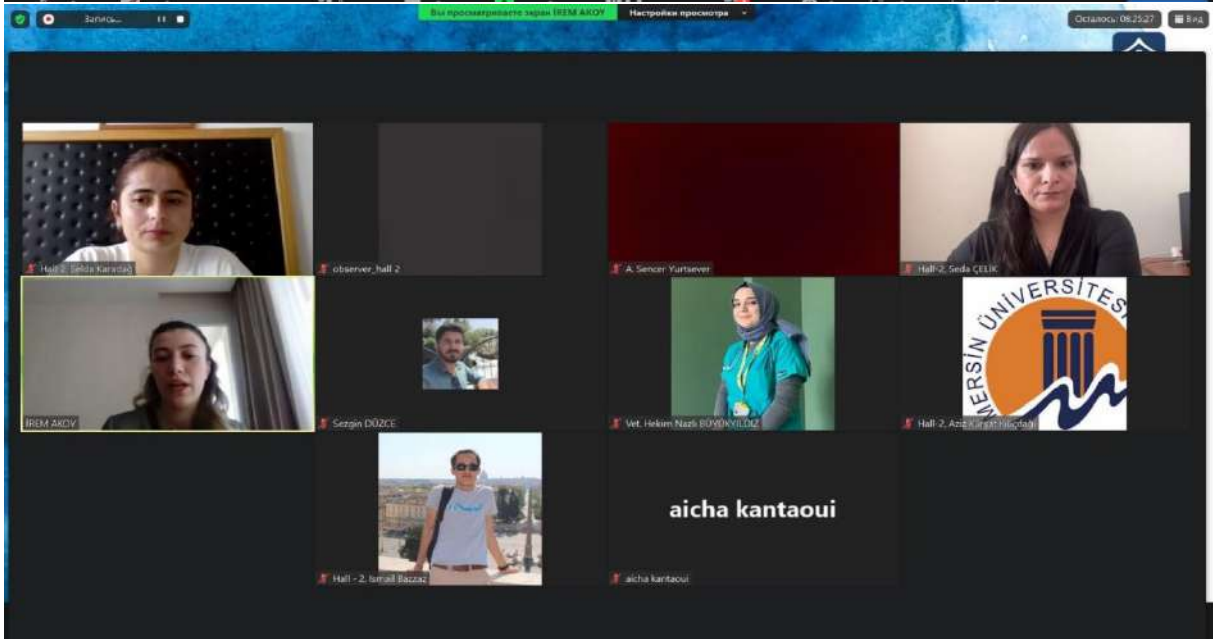
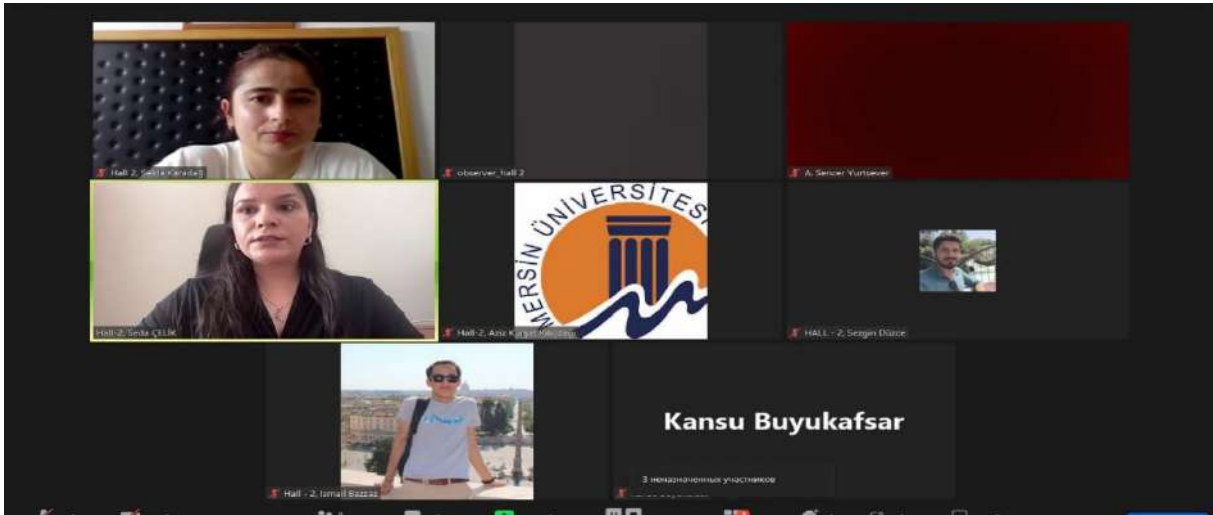

PHOTO GALLERY

Karar Destek Sistemleri ile Beyin Tümörü Sınıflandırması

Bünyamin ÖZER

Öğr. Gör. Dr. Sevinç Ay

Sorumlu Yazar: Doç. Dr. Derya AVCI

1 неиндивидуальный участник

HALL-2 Büşra Y...
HALL-2 Büşra YÖKSEL
observer_hall 2
HALL-2 OKAN GÜDER
Sefer Baday
Hall 2 - Bünyamin ÖZER

PREDICTION OF CHONDROITIN COMPETITIVE SULFOTRANSFERASE ENZYME INHIBITORS FOR THE TREATMENT OF ALZHEIMER'S DISEASE

Berna SOYSAL¹ and Sefer BADAY^{1,2}

¹Istanbul Technical University, Informatics Institute, Applied Informatics Department, Istanbul Türkiye
²Istanbul Technical University, Faculty of Computer Informatics and Engineering, Artificial Intelligence and Data Engineering Department, Istanbul 34469, Türkiye

1

HALL-2 Büşra Y...
HALL-2 Büşra YÖKSEL
observer_hall 2
HALL-2 OKAN GÜDER
Sefer Baday
M
H2 - Marve BALABAN

Buildre no para

Hall 2 İdris Demirsoy

Hall -2 Rashad Ablov

observer_hall 2

Dr. Vildemir | İsmail Tosun

Sellen Serban Vildor

Enes Kavak

Enes Kavak

1 неиндивидуальный участник

PHOTO GALLERY

Türkiye Orman Varlığı

Türkiye'de ormanlarının çoğunluğu devlete aittir ve Orman Genel Müdürlüğü (OGM) tarafından yönetilmektedir. OGM'nin 2020 yılı verilerine göre özel mülkiyete ait ormanlar toplam ormanlık alanın binde ikisinden daha azdır (OGM, 2021)

Türkiye Orman Varlığı Haritası (2020) (URL-1)

ÖZEL İSARETLER

- NORMAL KAPALI ORMAN
- BOĞURLU KAPALI ORMAN
- AÇIK ALANLAR
- DÖLME MÜDÜRLÜĞÜ SINIRI
- DÖLME BARIKLAR

EMRE KARAKAYA Enes Kavak

Hall 2 İdris Demiroz observer_hall 2 Dr. Yıldırım İsmail Tosun Mustafa DURAN

T.C.
ZONGULDAK BÜLENT ECEVİT ÜNİVERSİTESİ
LİSANSÜSTÜ EĞİTİM ENSTİTÜSÜ
GEOMATİK MÜHENDİSLİĞİ ANABİLİM DALI

KOMPSAT-5 SAR GÖRÜNTÜLERİ KULLANILARAK İNTERFEROMETRİK YÖNTEM İLE DEM ÜRETİLMESİ VE DOĞRULUK ANALİZİ

Öğrenci: Mustafa DURAN
Danışman: Dr.Öğr.Üyesi Eray KÖKSAL

HALL 2 Ayşen KILINÇER ÇOPUR observer_hall 2 Dr. ENGİN RAMAZANOĞLU

HALL 2 İdris Demiroz Hall 2 Duygu Dertli HALL 2 PARVİN NAJAFGÜLİYEV

EMRE KARAKAYA

2 незанятых участника

Выключить звук для всех

PHOTO GALLERY

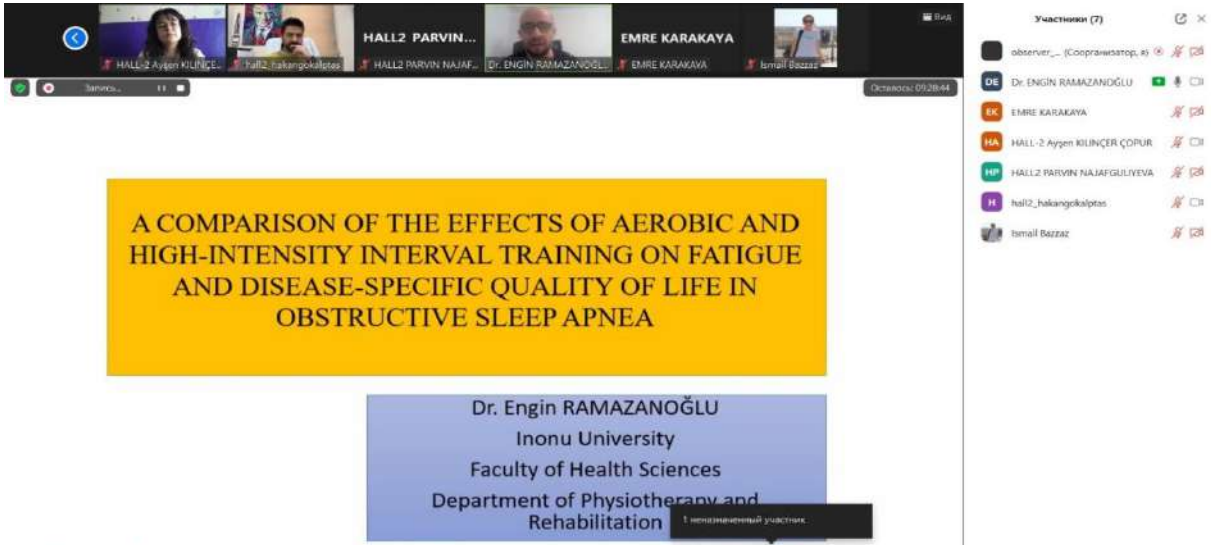

PHOTO GALLERY



PHOTO GALLERY

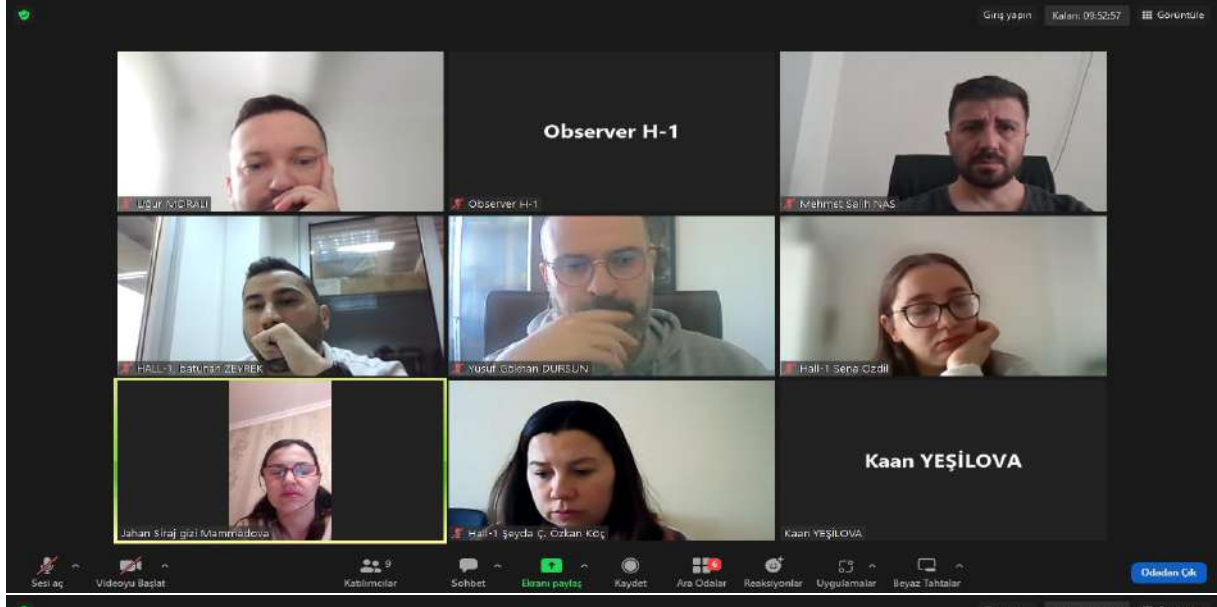
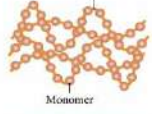

PHOTO GALLERY

Thermoplastic Polymer Composites

Thermoplastic

Strong link into polymer chains



Monomer

Weak intermolecular forces between polymer chains
No cross-links between chains
Softens when heated

Thermosetting

Strong cross-link bond



Monomer

Strong covalent bonds between polymer chains
Remains hard when heated

- Solid at room temperatures
- Mechanical structures of thermoplastics vary depending on the characteristics
- Used more commonly compared to thermosets, as they are recyclable.

- Lightweight, semi-crystalline polymer,
- Low electrical conductivity,
- Low UV resistance,
- Can have a brittle structure under some conditions.

Inorganic fillers !

RESIN CODE	COMMON
1 PET <small>Polyethylene Terephthalate</small>	Drink Bottles, Water Bottles
2 HDPE <small>High Density Polyethylene</small>	Milk Containers, Shampoo
3 PVC <small>Polyvinyl Chloride</small>	Cleaner Bottles, Kids' Toys, Sh
4 LDPE <small>Low Density Polyethylene</small>	Bread Bags, Trash Bags, Pili Bottles
5 PP <small>Polypropylene</small>	Food Containers
6 PS <small>Polystyrene (usually foamed)</small>	Meat Trays, Plastic Cups, P
7 OTHER <small>Various other plastics</small>	Reusable Bottles, Baby Bottles, Bio Plastics, Water Jug

Giriş yapın | Kalan: 09:55:37 | Görünüm

Observer H-1

Observer H-1

Hall-1, İlay Ünal

Hall-1, İlay Ünal

Gamze Göktepe

Observer H-1

Giriş yapın | Kalan: 09:55:37 | Görünüm

Observer H-1

Observer H-1

Hall-1, Ayarhan Ziyad, Zeynep Şirinova

yağmur kökten

Valeh

Perviz Allahyarov

Hall-1, Sessiz | +1 Nispet YERDİBEVA

Kemal Tiras

Hande Bulduk

Hilmi AKCAN

Giriş yapın | Kalan: 09:34:27 | Görünüm

Observer H-1

Observer H-1

Hr1 Prof. Dr. Emrullah FATİH

Observer H-1

Hr1 Mehmet ÜNAL

HALL-1 Mera YILDIRIM

Mehmet AKTULGA

H-1 Halis DEDE

Selin Çiltepe

Hr1 Selin Çiltepe

PHOTO GALLERY



PHOTO GALLERY



PHOTO GALLERY

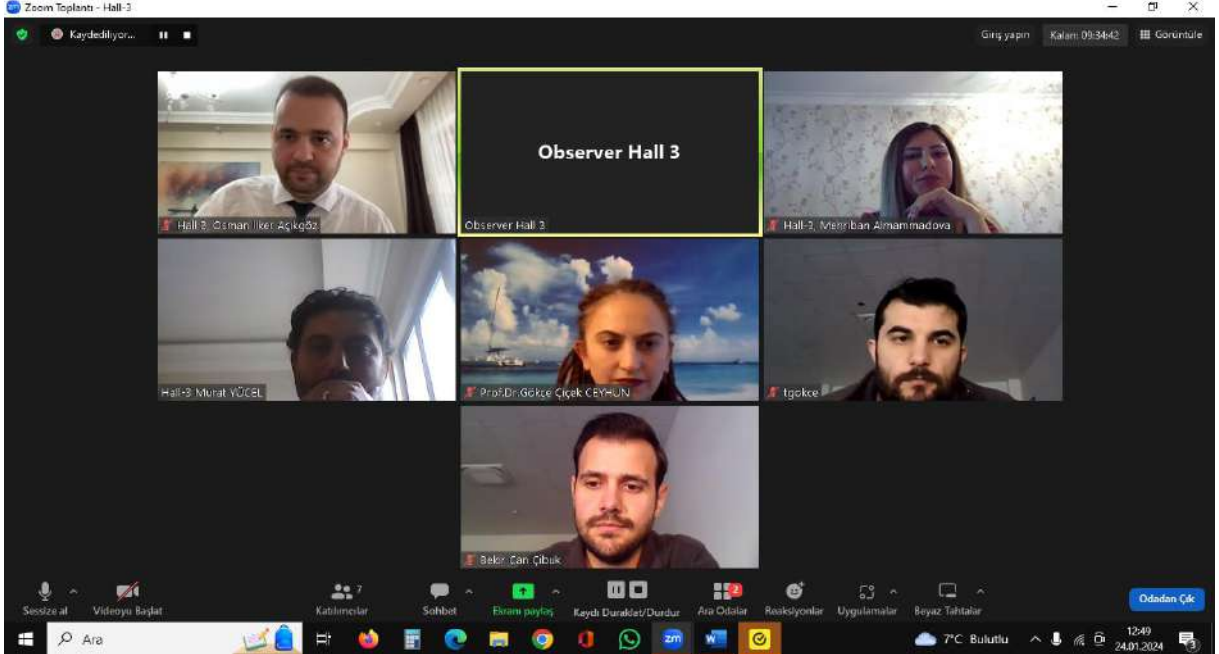
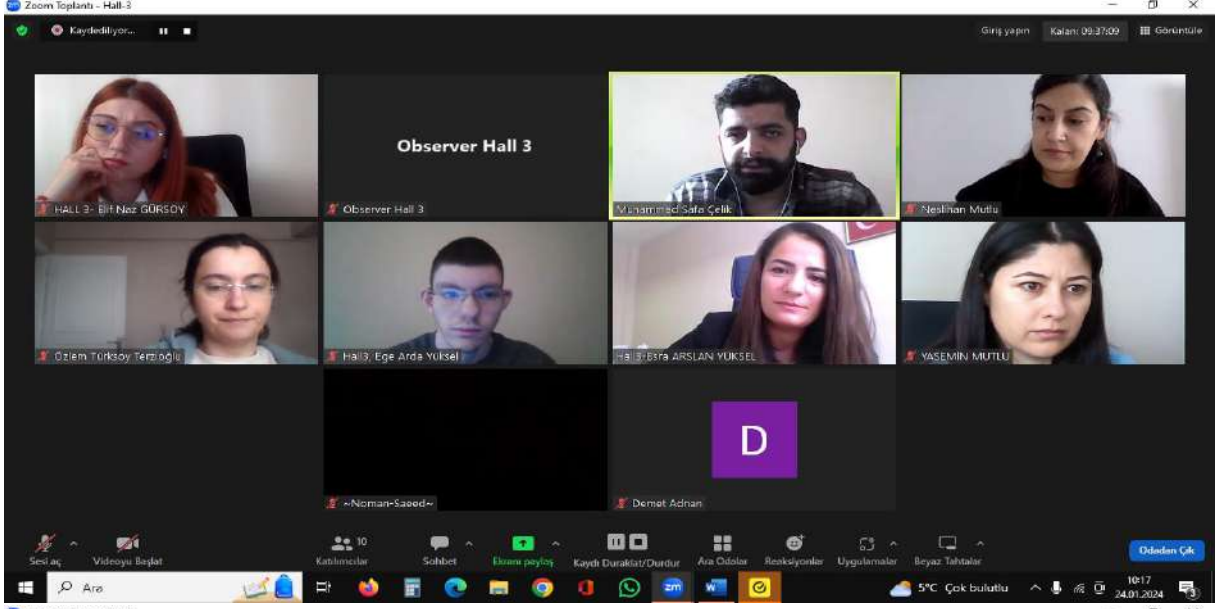

PHOTO GALLERY

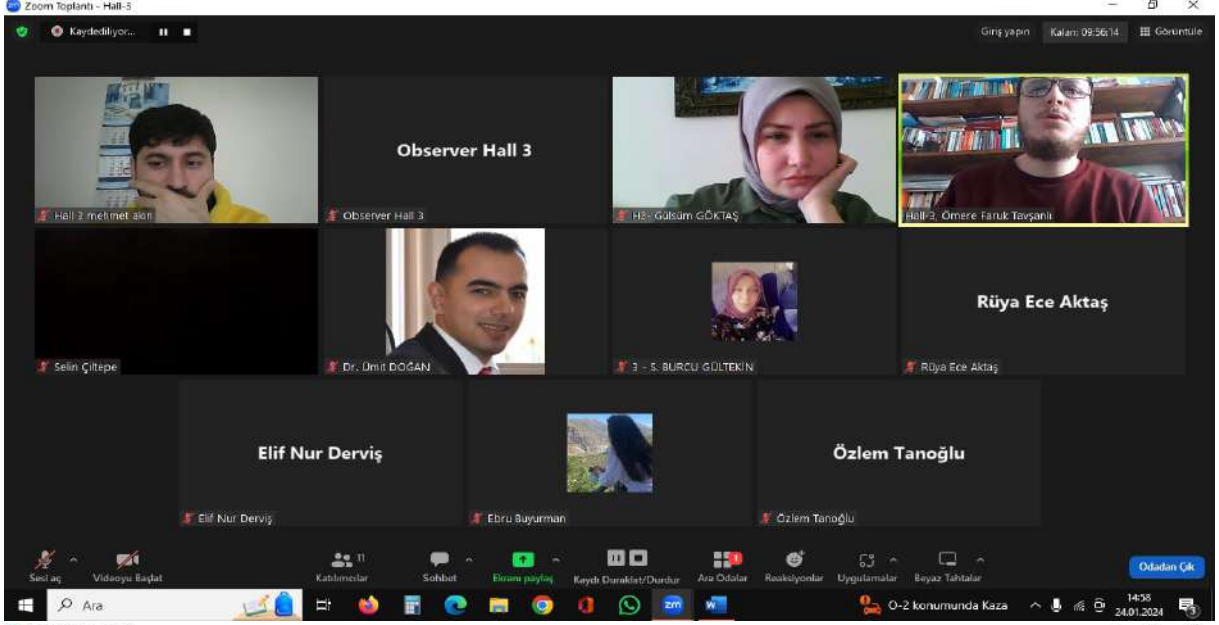

PHOTO GALLERY

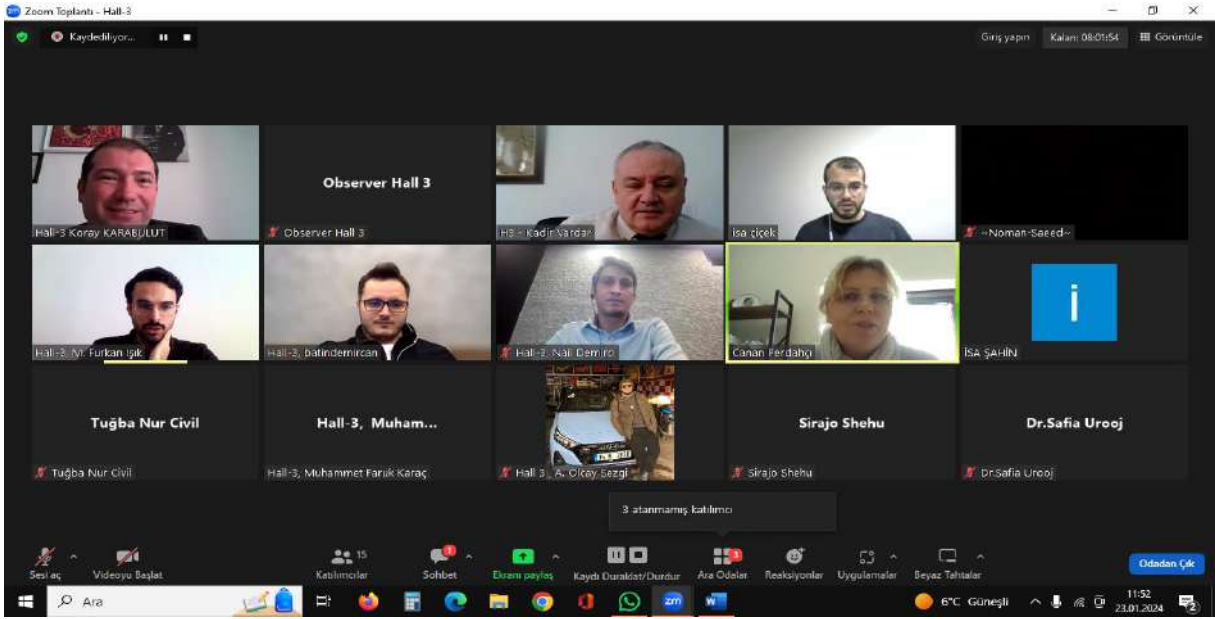
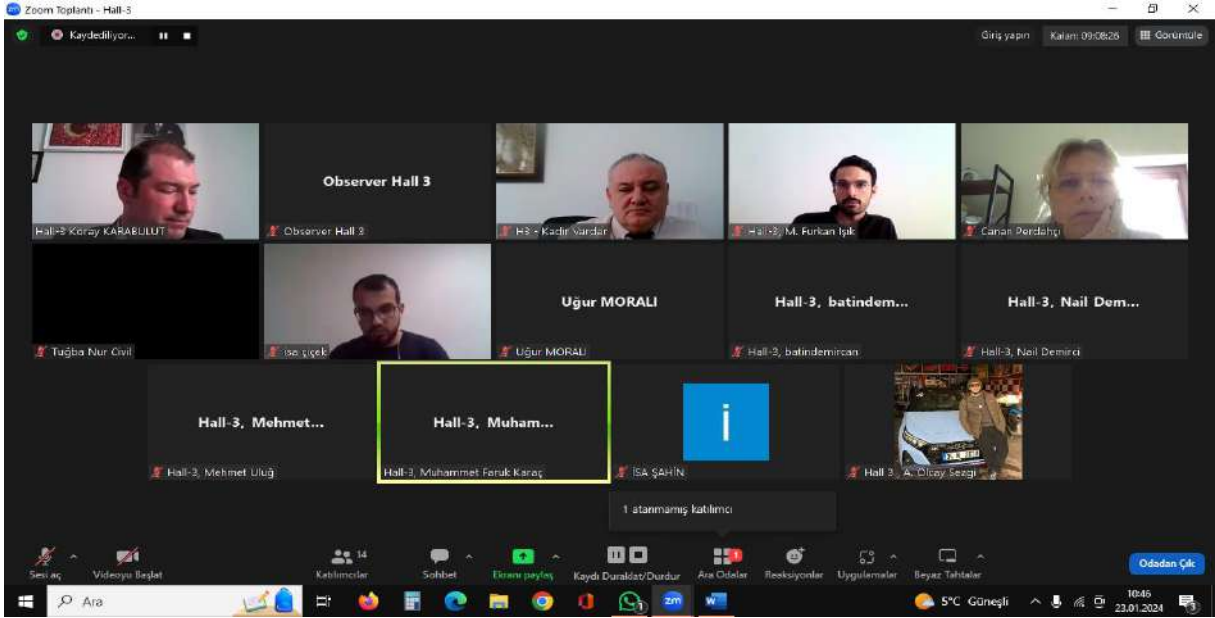

PHOTO GALLERY

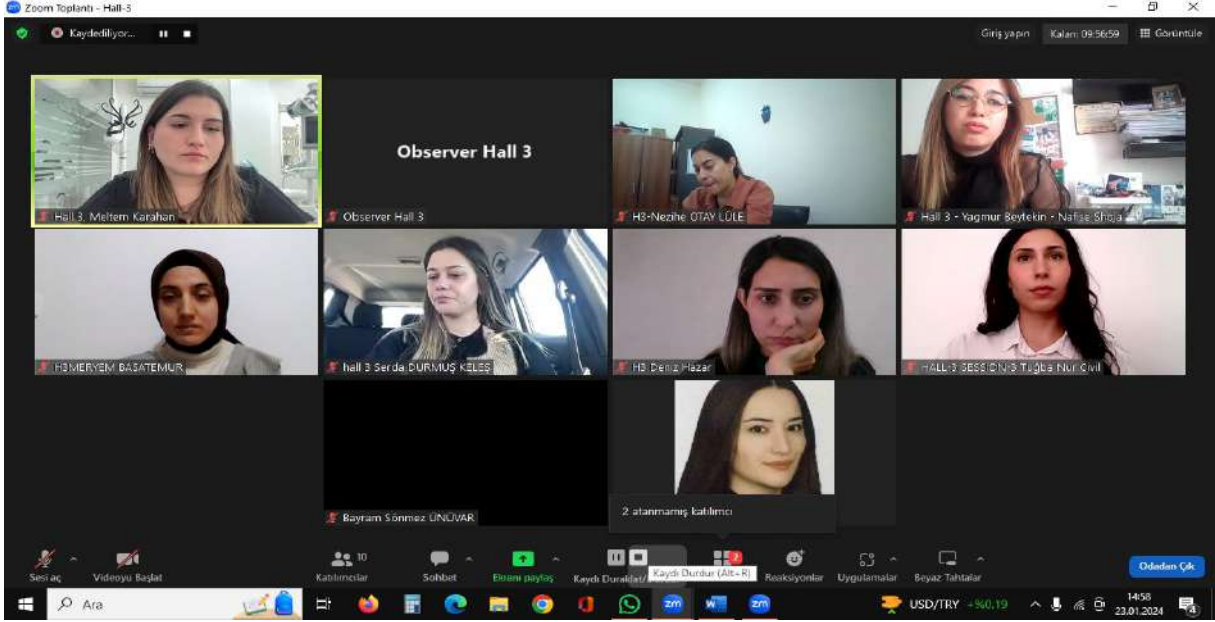

PHOTO GALLERY

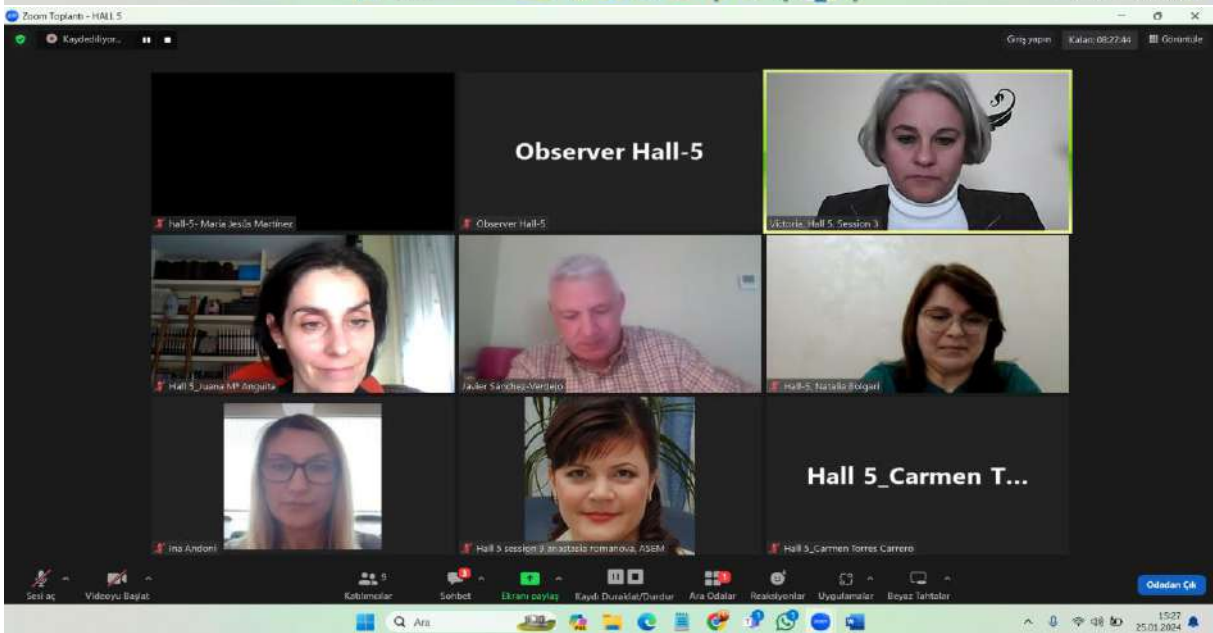

PHOTO GALLERY

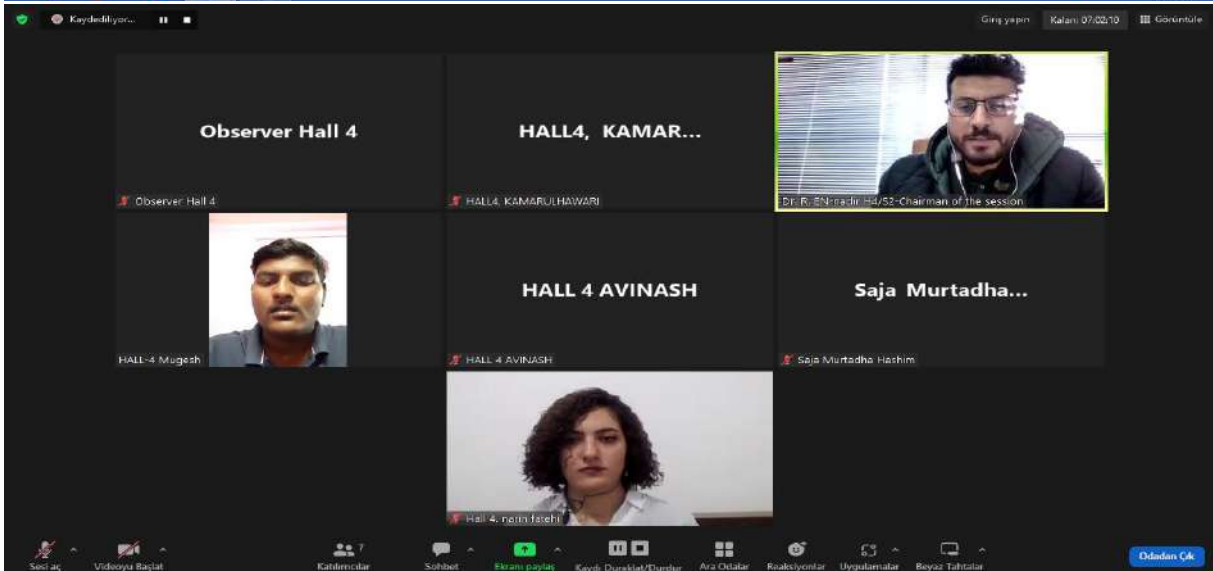
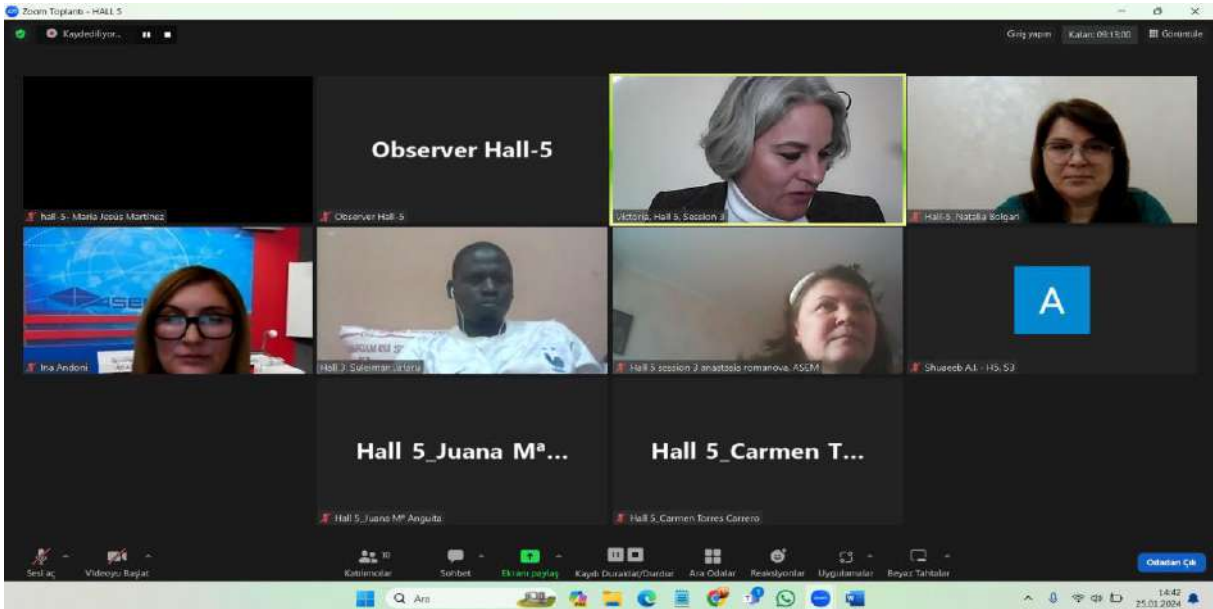

PHOTO GALLERY

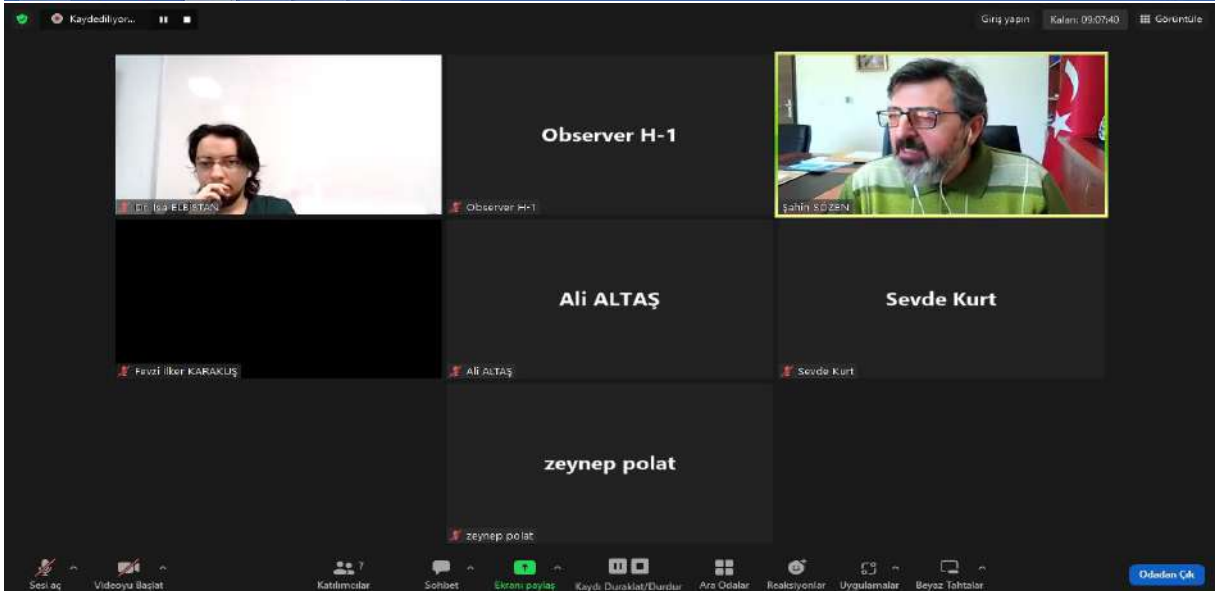
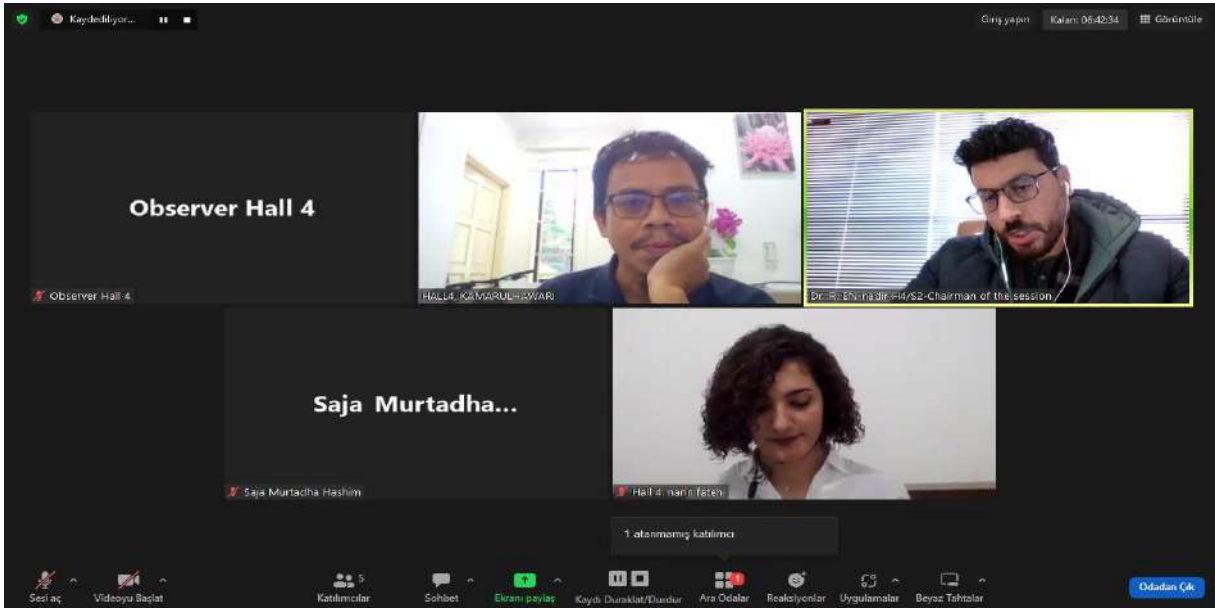

PHOTO GALLERY

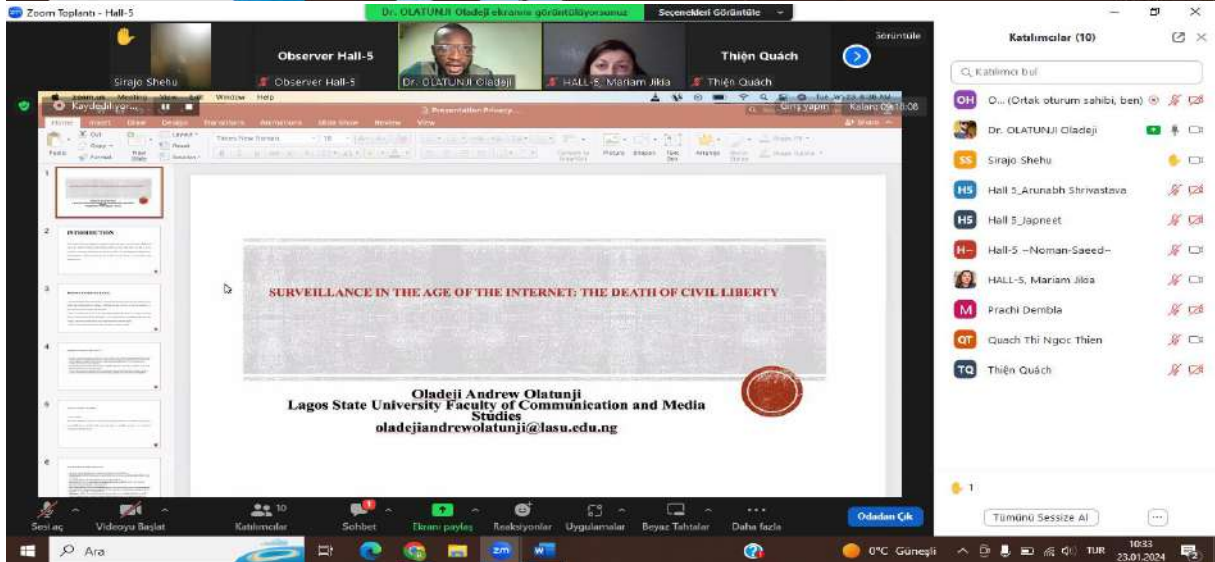
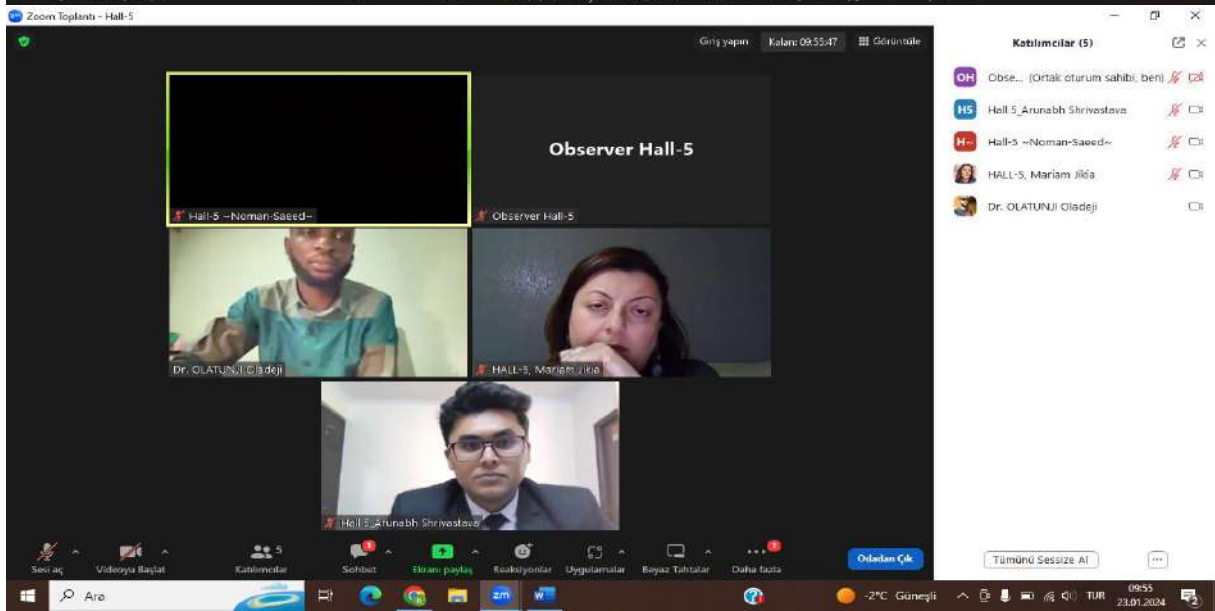
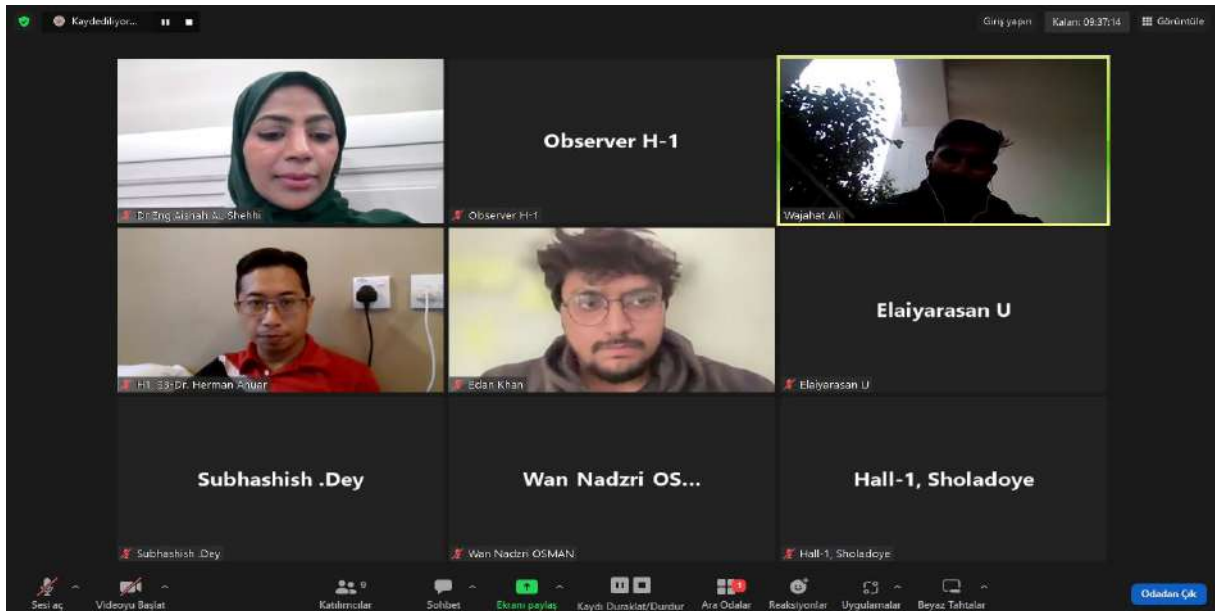

PHOTO GALLERY

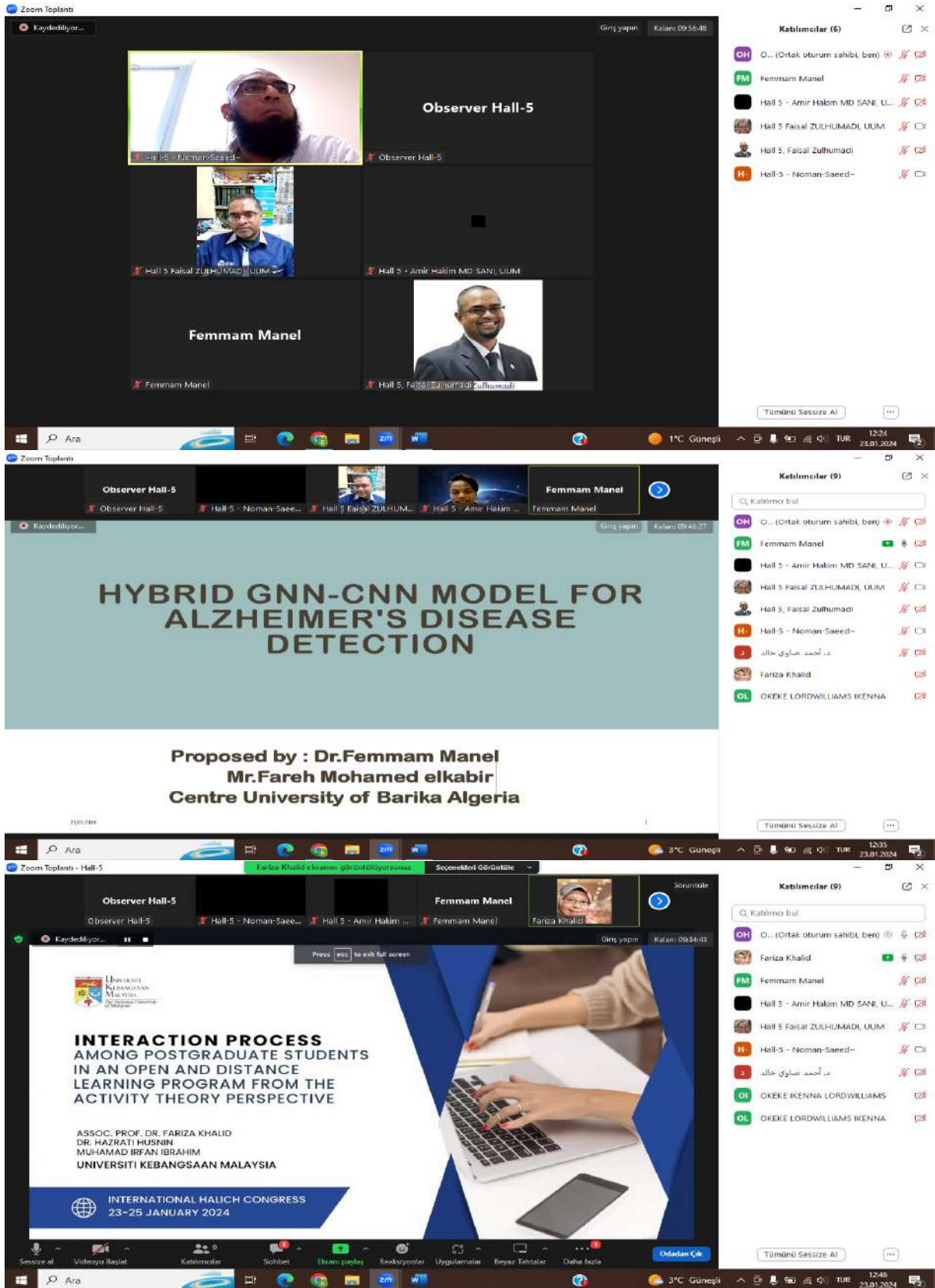

PHOTO GALLERY

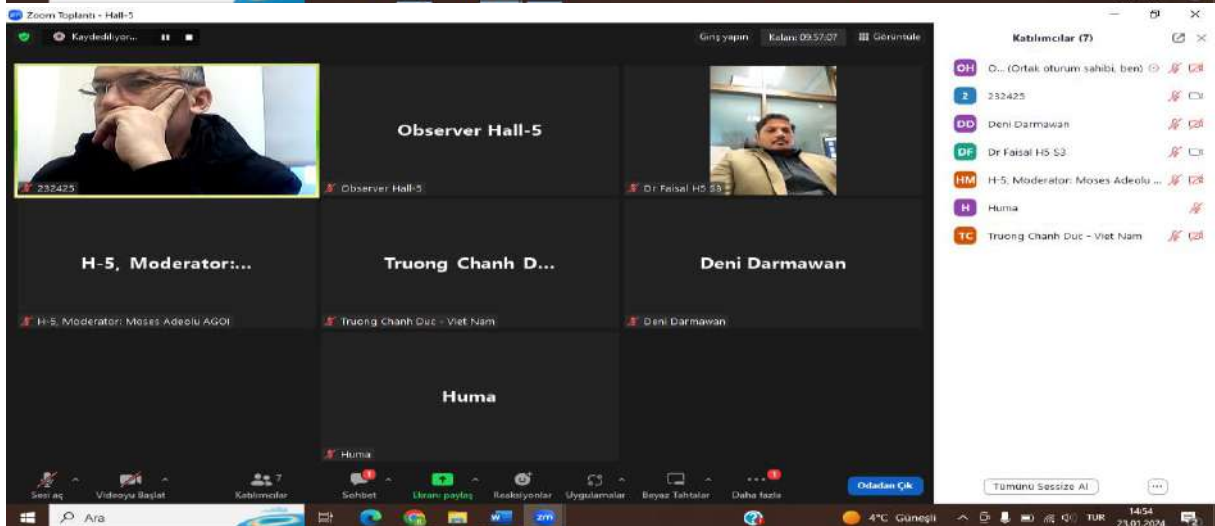
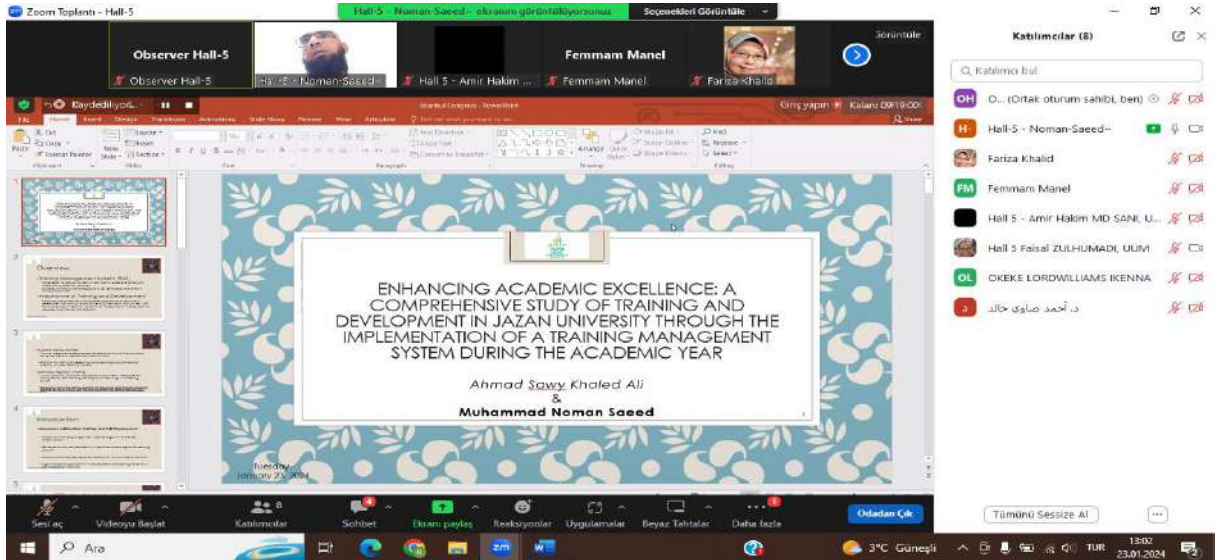

PHOTO GALLERY

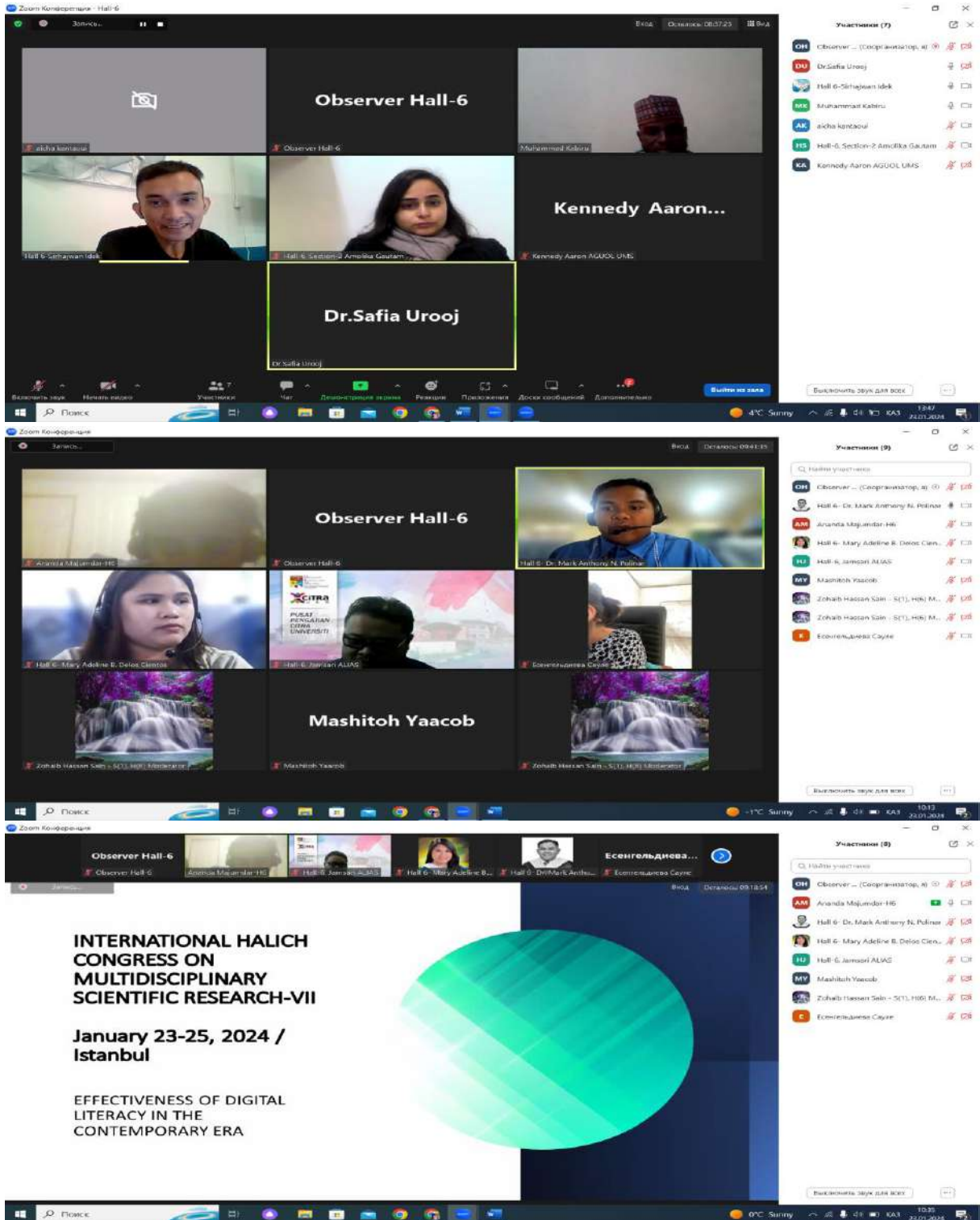

PHOTO GALLERY

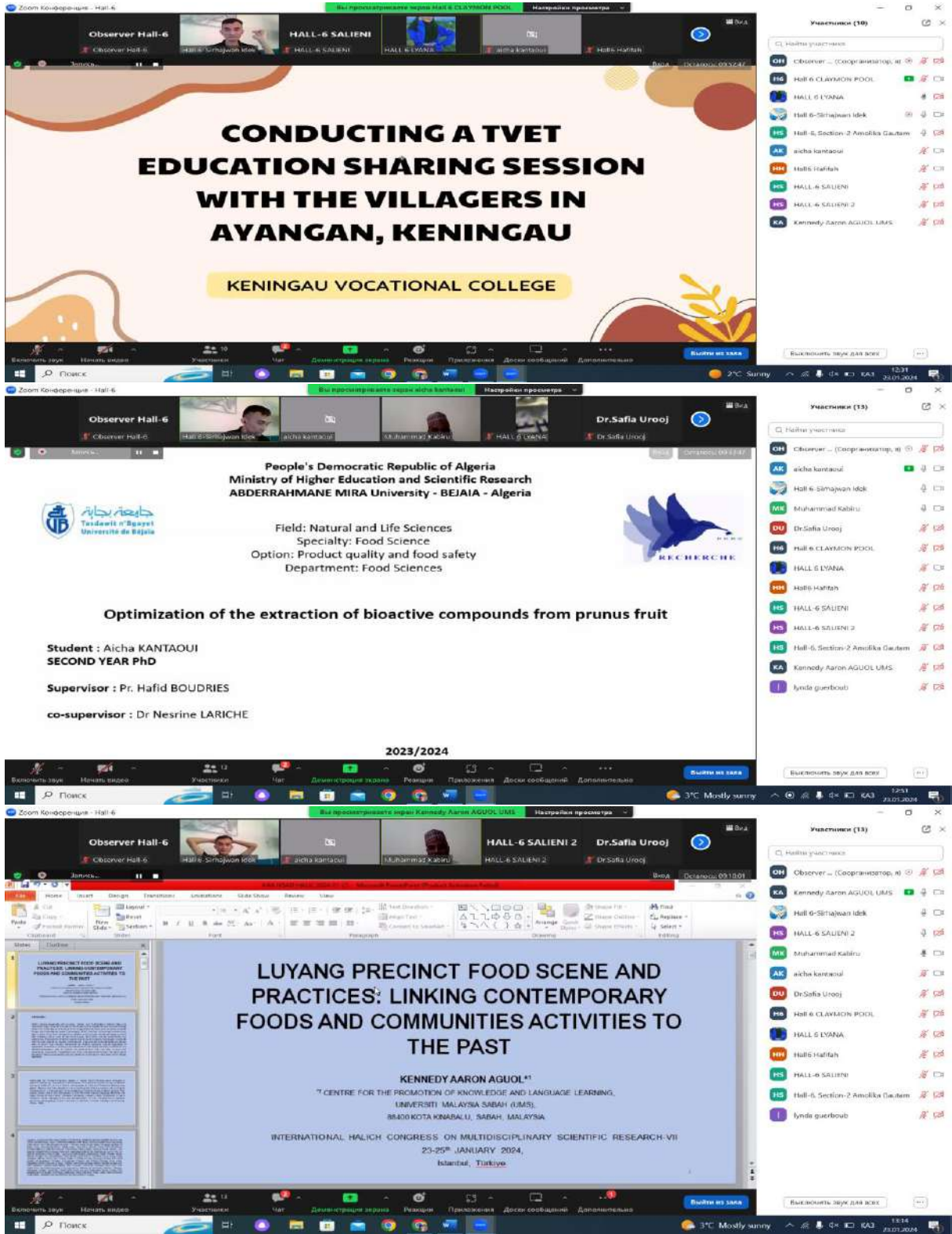

PHOTO GALLERY

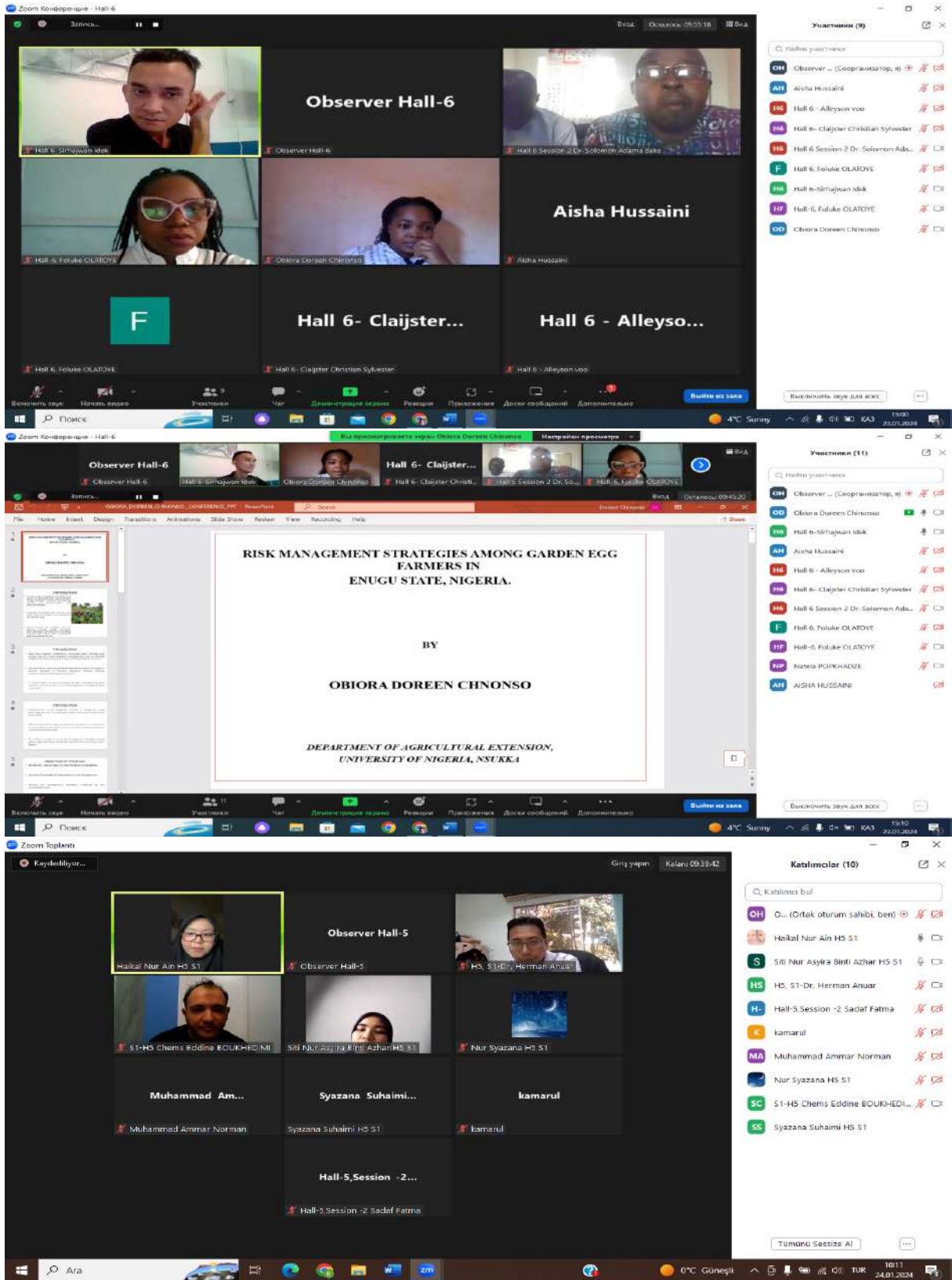

PHOTO GALLERY

Observer Hall-5

**SESSION 1, HALL 5, HERMAN ANUAR
WEDNESDAY (24/01/2024)
10:00AM-12:00PM**

**RESEARCH IN HALAL SUPPLY CHAIN
MANAGEMENT IN FROZEN FOOD
INDUSTRY: ISSUES AND CHALLENGES IN
NORTHERN KEDAH**

Assoc. Prof. Dr. Herman Shah Anuar, FCMi ;
Haikal Nur Ain binti Zulkifflee ; Siti Nur Asyira
binti Azhar ; Nur Syazana binti Suhaimi

herman@uum.edu.my ;
haikal_nur_ainestml.uum.edu.my ;
siti_nur_asyiraestml.uum.edu.my ;
nur_syazana5estml.uum.edu.my

Frozen Food

Katılımcılar (9)

- OH O... (Ortak oturum sahibi, ben)
- ES Syazana Suhaimi HS S1
- S Siti Nur Asyira Binti Azhar HS S1
- HS HS, S1-Dr. Herman Anuar
- H Haikal Nur Ain HS S1
- H Hall-5,Session -2 Sadaf Fatma
- MA Muhammad Ammar Norman
- Nur Syazana HS S1
- SC S1-HS Chems Eddine BOUKHEDIMI

Observer Hall-5

**SESSION 1, HALL 5, Herman Anuar
WEDNESDAY (24.01.2024)
10.00am-12.00PM**

**JOB SATISFACTION AMONG YOUTH IN MALAYSIA OIL AND GAS
INDUSTRY**

Assoc. Prof. Dr. Herman Shah Anuar, FCMi; Kyle Tan Jin Soon

herman@uum.edu.my;

MODERATOR: Dr. Chems Eddine BOUKHEDIMI

Katılımcılar (11)

- OH O... (Ortak oturum sahibi, ben)
- HS HS, S1-Dr. Herman Anuar
- Norman-Saeed-
- H Haikal Nur Ain HS S1
- H Hall-5,Session -2 Sadaf Fatma
- IC Ijeoma C. Ogbonnaya
- K kamarul
- MA Muhammad Ammar Norman
- Nur Syazana HS S1
- SC S1-HS Chems Eddine BOUKHEDIMI
- S Siti Nur Asyira Binti Azhar HS S1

Observer Hall-5

Hallo_Namrata Kumari

Observer Hall-5

aicha kantaoui

Hall 5,Session -2,Meeta Saxena

Cilya KACI

Hall-5,Session -2...

Cilya KACI

Hall-5,Session -2 Sadaf Fatma

Katılımcılar (6)

- OH O... (Ortak oturum sahibi, ben)
- P Hall 5,Session -2,Meeta Saxena
- HK Halls_Namrata Kumari
- AK aicha kantaoui
- CK Cilya KACI
- H Hall-5,Session -2 Sadaf Fatma

PHOTO GALLERY

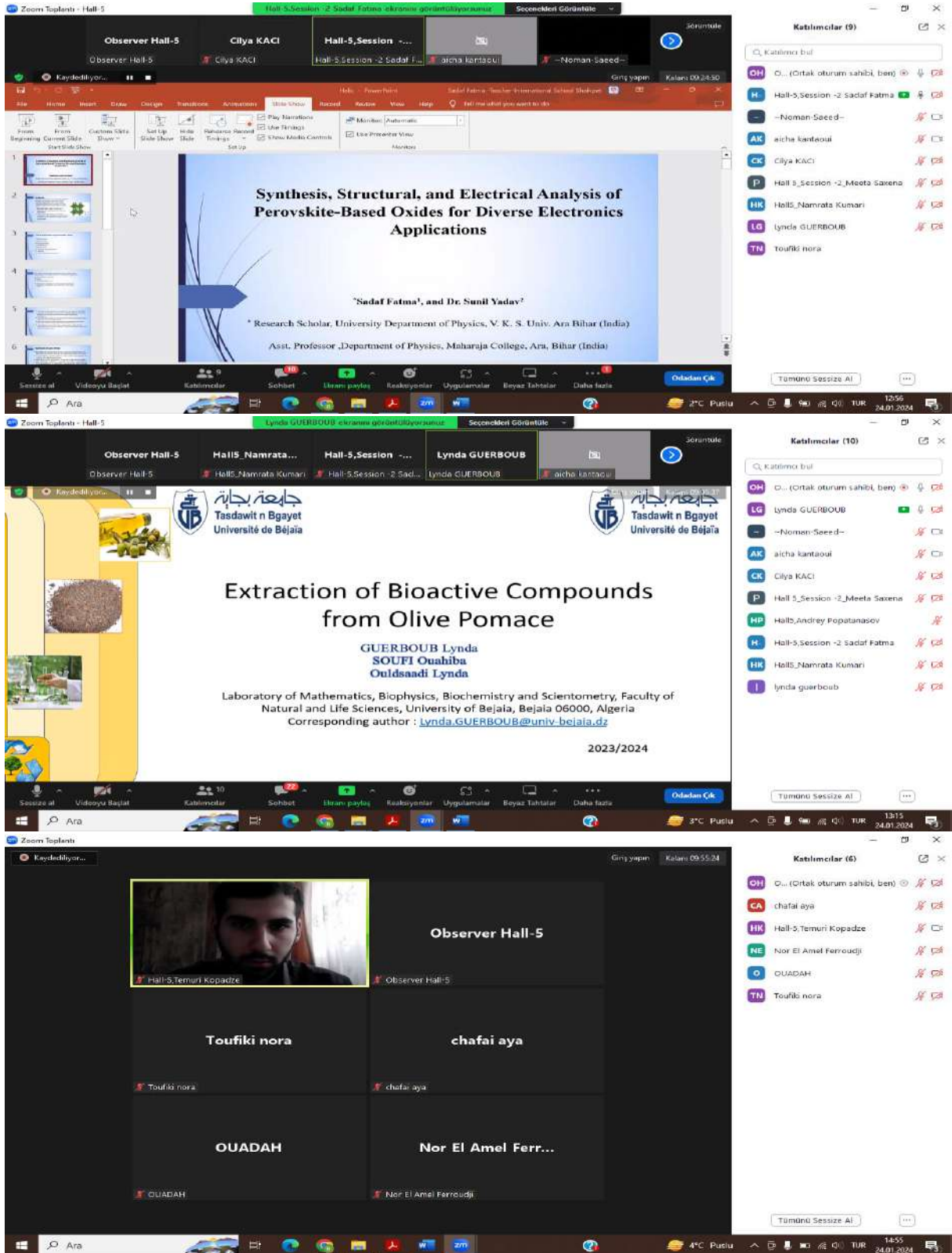

PHOTO GALLERY

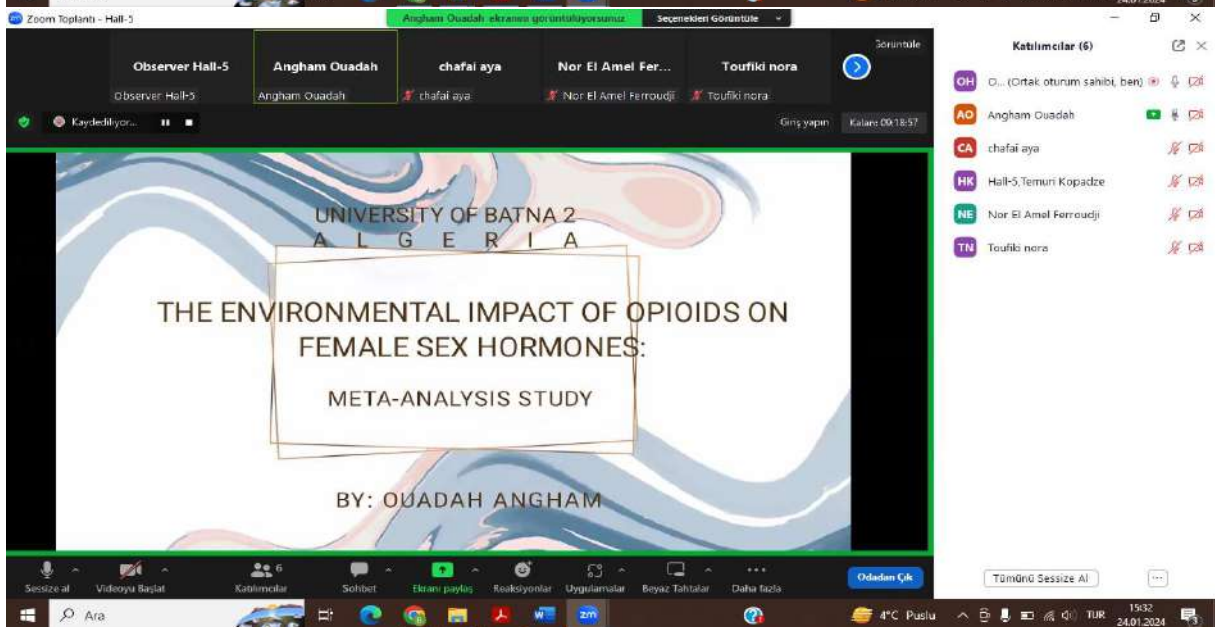
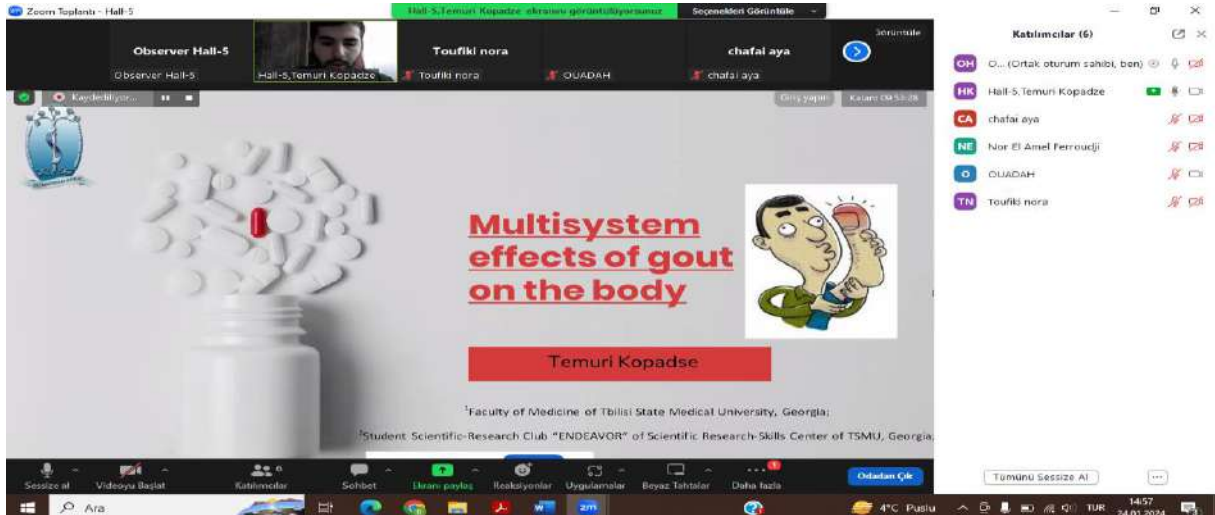

PHOTO GALLERY

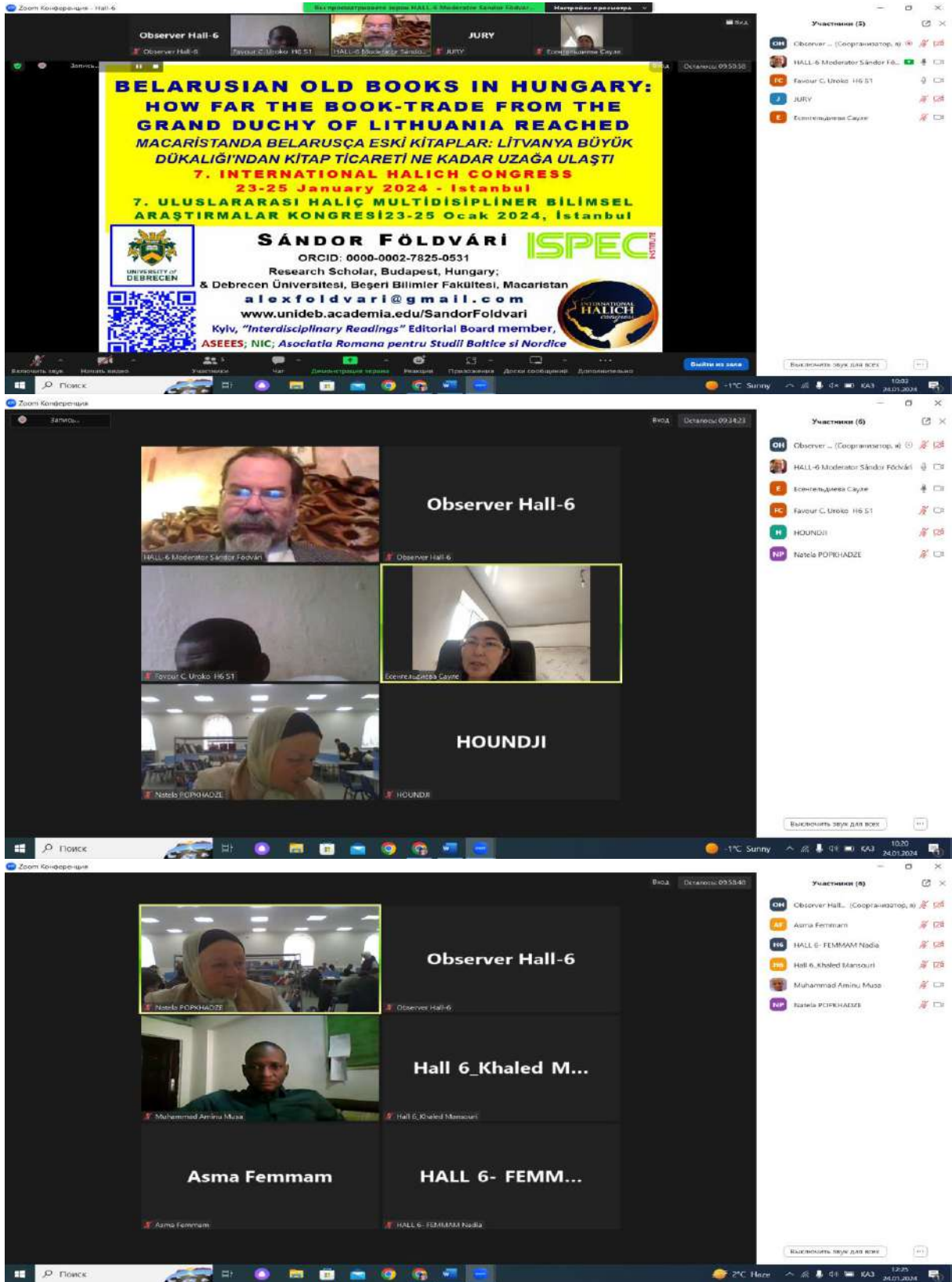

PHOTO GALLERY

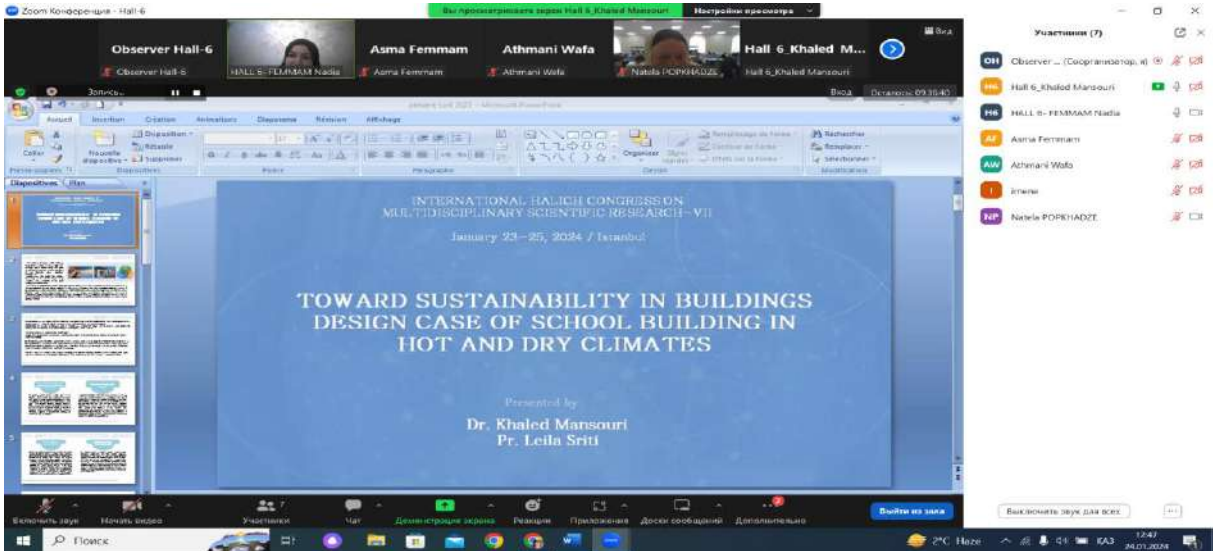

PHOTO GALLERY

Ali ALTAŞ ekranını gösteriyorsunuz Seçenekleri Gözetin

3.YÖNTEM
3.1]Standartlaştırılmış Yağış İndisi- SPIMKee ve diğ. (1993)

$$SPI = \frac{x_i - x_{ort}}{\sigma}$$

- α : Şekil parametresi
- β : Ölçek parametresi
- x : Aylık yağış miktarı
- $\Gamma(\alpha)$: Gamma PDF
- $p(x)$: Olasılık değeri

$$p(x) = \frac{1}{\beta^\alpha \Gamma(\alpha)} x^{\alpha-1} e^{-\frac{x}{\beta}}$$
$$\mu = \ln(x_{ort}) - \frac{\sum \ln(x)}{n}$$
$$\alpha = \frac{1}{4\mu} \left(1 + \sqrt{1 + \frac{4\mu}{3}} \right)$$
$$\beta = \frac{x_{ort}}{\alpha}$$
$$P(x) = \int_0^x p(x) dx = \frac{1}{\beta^\alpha \Gamma(\alpha)} \int_0^x x^{\alpha-1} e^{-\frac{x}{\beta}} dx$$

yağış miktarı 0 olan veri için $G(x) = \frac{n}{c} + \left(1 - \frac{n}{c} \right) P(x)$

SPI	Kuraklık sınıfı
$SPI \geq 2$	Aşırı Islak
$1.50 > SPI > 1.99$	Çok Islak
$1.00 > SPI > 1.49$	Orta ıslak
$0.99 > SPI > -0.99$	Normal
$-1.00 > SPI > -1.49$	Orta Kurak
$-1.50 > SPI > -1.99$	Çok Kurak
$-2.00 > SPI$	Aşırı Kurak

Çizelge 3.1 : SPI Kuraklık sınıfları.

Observer H-1

Observer H-1

Şahin EZZEN

Ali ALTAŞ

Sevi aç Videoya Başlat Katılımcılar Sohbet Ekranı Paylaş Kayıt Duraklat/Durdur Ara Odalar Reaksiyonlar Uygulamalar Beyaz Tahtalar Odadan Çık

Prof. Dr. Tahir Bolo

Arş. Gör. Sürrey...

Uğur KAVAL-Dic...

hall 2 Prof. Dr...

Günel Hacıyeva

Sevi aç Videoya Başlat Katılımcılar Sohbet Ekranı Paylaş Kayıt Duraklat/Durdur Ara Odalar Reaksiyonlar Uygulamalar Beyaz Tahtalar Odadan Çık

S. Yusuf DEMİROZ

Observer Ülkü H-2

Mustafa Kuvan

Zeynep Ustaoglu

Sabina Garashova

Hall-2 Serap E.K...

Ragini kahera

Doç. Dr. AYRAC ALTUN

Sevi aç Videoya Başlat Katılımcılar Sohbet Ekranı Paylaş Kayıt Duraklat/Durdur Ara Odalar Reaksiyonlar Uygulamalar Beyaz Tahtalar Odadan Çık



INTERNATIONAL HALICH CONGRESS ON MULTIDISCIPLINARY SCIENTIFIC RESEARCH-VII

January 23-25, 2024 / Istanbul

CONGRESS PROGRAM

Online (with ZOOM Conference)

Meeting ID: 871 0713 9228

Passcode: 232425

Join Zoom Meeting:

<https://us02web.zoom.us/j/87107139228?pwd=b0dGalg3cWJsMkZoekdBL0pOeVR1QT09>



IMPORTANT, PLEASE READ CAREFULLY

- ❖ To be able to attend a meeting online, login via <https://zoom.us/join> site, enter ID “Meeting ID or Personal Link Name” and solidify the session.
- ❖ The Zoom application is free and no need to create an account.
- ❖ The Zoom application can be used without registration.
- ❖ The application works on tablets, phones and PCs.
- ❖ The participant must be connected to the session 5 minutes before the presentation time.
- ❖ All congress participants can connect live and listen to all sessions.
- ❖ Moderator is responsible for the presentation and scientific discussion (question-answer) section of the session.

Points to Take into Consideration - TECHNICAL INFORMATION

- ◆ Make sure your computer has a microphone and is working.
- ◆ You should be able to use screen sharing feature in Zoom.
- ◆ Attendance certificates will be sent to you as pdf at the end of the congress.
- ◆ Requests such as change of place and time will not be taken into consideration in the congress program.

Önemli, Dikkatle Okuyunuz Lütfen

- ❖ Kongremizde Yazım Kurallarına uygun gönderilmiş ve bilim kurulundan geçen bildirimler için online (video konferans sistemi üzerinden) sunum imkanı sağlanmıştır.
- ❖ Online sunum yapabilmek için <https://zoom.us/join> sitesi üzerinden giriş yaparak “Meeting ID or Personal Link Name” yerine ID numarasını girerek oturuma katılabilirsiniz.
- ❖ Zoom uygulaması ücretsizdir ve hesap oluşturmaya gerek yoktur.
- ❖ Zoom uygulaması kaydolmadan kullanılabilir.
- ❖ Uygulama tablet, telefon ve PC’lerde çalışıyor.
- ❖ Her oturumdaki sunucular, sunum saatinden 5 dk öncesinde oturuma bağlanmış olmaları gerekmektedir.
- ❖ Tüm kongre katılımcıları canlı bağlanarak tüm oturumları dinleyebilir.
- ❖ Moderatör - oturumdaki sunum ve bilimsel tartışma (soru-cevap) kısmından sorumludur.

Dikkat Edilmesi Gerekenler- TEKNİK BİLGİLER



- ◆ Bilgisayarınızda mikrofon olduğuna ve çalıştığına emin olun.
- ◆ Zoom'da ekran paylaşma özelliğine kullanabilmelisiniz.
- ◆ Kabul edilen bildiri sahiplerinin mail adreslerine Zoom uygulamasında oluşturduğumuz oturuma ait ID numarası gönderilecektir.
- ◆ Katılım belgeleri kongre sonunda tarafınıza pdf olarak gönderilecektir
- ◆ Kongre programında yer ve saat değişikliği gibi talepler dikkate alınmayacaktır

Before you login to Zoom please indicate your name_surname and HALL number:

exp. Hall-1, Shalini JAISWAL



Participant Countries

Türkiye, Azerbaijan, Kazakhstan, Indonesia, Pakistan, Nigeria, Canada, Serbia, Cyprus, Algeria, India, Malaysia, Morocco, Ukraine, Macedonia, Vietnam, Bulgaria, Mongolia, Georgia, Kosovo, Moldova, Iraq, Brazil, Romania, Philippines, United Arab Emirates, Russia, South Africa, Albania, Hungary, Spain, Iran

 DATE	• 23.01.2024	 TIME	• 10⁰⁰–12⁰⁰	 SESSION	• HALL-1 • SESSION-1
--	---------------------	--	--	---	---------------------------------



HEAD OF SESSION: Prof. Dr. Nisbet MEHDİYEVA

Lec. Dr. Hande BULDUK	Gazi University	FICTIONAL FUNCTION OF SUPERSTITION ELEMENTS IN THE NOVELS OF SELÂMİ İZZET SEDES
Kemal TIRAŞ Assoc. Prof. Dr. Funda DEMİRTAŞ	Erciyes University	THE IMPORTANCE OF HUNTING ACTIVITIES IN THE FOUNDING YEARS OF THE OTTOMAN EMPIRE
Ayethan Ziyad (İskenderov) Zemfire Shirinova	Azerbaijan State Pedagogical University	HAYDAR ALİYEV: PRIDE OF OUR NATIONAL IDENTITY
Yağmur KÖFTER KURT	Bartın University	19TH CENTURY TURKISH CEMETERY CULTURE THROUGH THE EYES OF FOREIGN VOYAGERS TRAVELLING TO THE OTTOMAN EMPIRE
Prof. Dr. Nisbet MEHDİYEVA	Baku State University	THE SCIENCE IN BASHKORTOSTAN (XIX – BEGINNING OF XXTH CENTURY)
Assoc. Prof. Dr. Erol AKCAN	Trakya University	THE MURDER OF HALIT PASHA AS A HISTORICAL EVENT AND FROM THE PERSPECTIVE OF TURKISH HISTORIOGRAPHY
Allahverdiyev Pərviz Rəşad oğlu Əlixanov Valeh Məmməd oğlu	Nakhchivan State University	QARABAĞ TORPAQLARININ İŞXALDAN AZAD EDİLMƏSİ KEÇMİŞİMİZDƏN BU GÜNÜMÜZƏ.
Lec. Yahya İNCETAHTACI	Ankara Hacı Bayram Veli University	THE TWO FACES OF UTILITARIANISM; EXAMPLES OF JEREMY BENTHAM AND AYN RAND

 DATE	• 23.01.2024	 TIME	• 10⁰⁰–12⁰⁰	 SESSION	• HALL-2 • SESSION-1
--	---------------------	--	--	---	---------------------------------------



HEAD OF SESSION: **Dr. Yıldırım İsmail Tosun**

İdris Demirsoy	Usak University	FORECASTING TOGG ELECTRIC VEHICLE PRICE IN EUROPE: AN INTEGRATED ANALYSIS
Abilov Rashad Saffan oglu Aliyeva Parvin Zakir	Azerbaijan Research and Design Institute for Energy	SCIENTIFIC JUSTIFICATION OF THE ESTABLISHMENT OF MIRIK SMALL WATER POWER STATION ON ZABUKH RIVER, LACHIN DISTRICT
Asst. Prof. Dr. Selim Serhan YILDIZ	Osmaniye Korkut Ata University	DETERMINATION OF BURNT FOREST AREAS AFTER THE 2023 İZMİR MENDERES FOREST FIRE ACCORDING TO BURNING INTENSITY USING THE GOOGLE EARTH ENGINE
Mustafa DURAN Asst. Prof. Dr. Eray KÖKSAL Assoc. Prof. Dr. Çağlar BAYIK	Zonguldak Bülent Ecevit University	DEM PRODUCTION AND ACCURACY ANALYSIS BY INTERFEROMETRIC METHOD USING KOMPSAT-5 SAR IMAGES
Emre Karakaya Bilgehan Kekeç Niyazi Bilim	Konya Technical University	THE RELATIONSHIP BETWEEN TEXTURE COEFFICIENT (TC) VALUES OF MAGMATIC ROCKS AND BÖHME ABRASIVENESS VALUES
Dr. Yıldırım İsmail Tosun	Şırnak University	SAWING DISC TEST FOR ROCK FALLING RISK OF ŞIRNAK ASPHALTITE QUARRY- STUDY ON CEMENTED CRACKS OF SHALE, MARLY CLAYSTONE FOR UPPER SLOPE'S STABILITY
Dr. Yıldırım İsmail Tosun	Şırnak University	MICROWAVE AUTOPYROLYSIS OF COAL IN NH ₃ BED BY Ca -FERRITE/ SERPENTINITE FINE
Enes KAVAK Prof. Dr. Hacı BODUR	Yıldız Technical University	ANALYSIS OF A 1/8 BRICK-SIZED, HIGH POWER DENSITY, AND FOUR SWITCH BUCK-BOOST DC-DC CONVERTER FOR MILITARY AVIATION APPLICATIONS

 DATE	• 23.01.2024	 TIME	• 10⁰⁰–12⁰⁰	 SESSION	• HALL-3 • SESSION-1
--	---------------------	--	--	---	---------------------------------------



HEAD OF SESSION: Assoc. Prof. Dr. Koray KARABULUT

Asst. Prof. Dr. Kadir VARDAR	Kütahya Dumlupınar University	INVESTIGATION OF THE EFFECT OF DEAD TIME IN INDIRECT FIELD ORIENTED CONTROL OF INDUCTION MOTOR
Muhammet Furkan IŞIK	Ankara Yıldırım Beyazıt University	A BRIEF REVIEW ON DEEP LEARNING IN APPLICATION OF CHANNEL ESTIMATION
Assoc. Prof. Canan PERDAHÇI Mehmet Ufuk ULUĞ Yusuf Özkan ÖRNEK Atahan Olcay SEZGİ	Kocaeli University Na-De Electronics Research and Development Department	CHEAPER AND MORE EFFICIENT LIGHTING WITH LED LUMINAIRES
Muhammet Faruk KARAÇ Mehmet Ufuk ULUĞ Yusuf Özkan ÖRNEK Assoc. Prof. Dr. Canan PERDAHÇI	Kocaeli University DMY Elektrik Otomasyon Aydınlatma San. ve Tic. A.Ş.	HUMAN DETECTION WITH ANALOG PIR SENSOR
İsa ŞAHİN	Kocaeli University	HC-06 SMART INTERCOM COMMUNICATION CIRCUIT VIA BLUETOOTH MODULE AND WIFI
İsa ÇİÇEK Asst. Prof. Dr. Merdin DANIŞMAZ	Kırşehir Ahi Evran University	EXPERIMENTAL INVESTIGATION OF THE USE OF WATER-BASED Al ₂ O ₃ NANOFUID AS REFRIGERANT IN PHOTOVOLTAIC THERMAL PANELS
Asst. Prof. Dr. Yeliz ALNAK Assoc. Prof. Dr. Koray KARABULUT	Sivas Cumhuriyet University	EVALUATION OF MULTI-IMPINGING JET FLOW EFFECT IN COOLING OF VARIOUS GEOMETRIC MODEL SURFACES
Nail DEMİRCİ Lecturer Batın DEMİRCAN	ISBIR Electric Co, Balıkesir University	DEVELOPMENT OF MICRO COGENERATION SYSTEM WITH DIESEL GENERATOR

		
DATE	TIME	SESSION
• 23.01.2024	• 10⁰⁰-12⁰⁰	• HALL-4 • SESSION-1



HEAD OF SESSION: Asst. Prof. Dr. Saygun GÖKARIKSEL

Dr. Menderes KURT	---	THE TRANSFORMATION YEARS OF THE MIDDLE EAST: "WHAT DOES 'DETENTE' MEAN FOR THE REGION?"
Javid YUSUBOV	Academy of Public Administration under the President of the Republic of Azerbaijan	EVOLUTION OF POLITICAL SYSTEMS IN POST-SOVIET NATIONS AMIDST THE EMERGING GLOBAL ORDER
Asst. Prof. Dr. Saygun GÖKARIKSEL	Boğaziçi University	TOWARD A CRITICAL SOCIAL-HISTORICAL UNDERSTANDING OF EASTERN EUROPE: BEYOND EUROCENTRIC AND COLD WAR PARADIGMS
Dr. Seyhan SARICA KELLE	---	EXPLORING GLOBAL LEADERSHIP TRANSITIONS IN LIGHT OF THE PANDEMICS: A COMPARATIVE ANALYSIS OF THE INFLUENZA OF 1918 AND COVID-19
Dr. Muhammet Yasin ELİTOK	Atatürk University	THE PRINCIPLES OF AGENDA SETTING IN THE PRINTED MEDIA AND AN ANALYSIS ON THE 2017 CONSTITUTIONAL AMENDMENT REFERENDUM WITH IN THE SCOPE OF THESE PRINCIPLES
Dr. Muhammet Yasin ELİTOK	Atatürk University	A COMPARATIVE ANALYSIS ON THE CONCEPT OF POLITICAL LITERACY AND POLITICAL CONSENT IN THE CONTEXT OF POLITICAL PARTY ORIENTATIONS OF VOTER GROUPS
Namig Bağirli	Genocide Memorial Complex in Guba city	THE SIGNIFICANCE AND IMPORTANCE OF GENOCIDE MEMORIAL COMPLEXES
Daniel Johnson	Bilkent University	CRIME AND CULTURE IN THE ATLANTIC WORLD: THE CASE OF THE PHILADELPHIA ROBBERS

 DATE	• 23.01.2024	 TIME	• 10⁰⁰–12⁰⁰	 SESSION	• HALL-5 • SESSION-1
--	---------------------	--	--	---	---------------------------------



HEAD OF SESSION: Prof. Dr. Mariam Jikia

Arunabh Shrivastava	Symbiosis Law School	HARMONIZING CYBERSPACE AND INTELLECTUAL PROPERTY: UNVEILING COMPLEXITIES, NAVIGATING CHALLENGES, AND CHARTING FUTURE COLLABORATIONS
Mrs. Quách Thị Ngọc Thiện	Sai Gon University	INTELLECTUAL PROPERTY RIGHTS AND TECHNOLOGY TRANSFER IN VIETNAM - LEGAL REGULATIONS AND SOLUTIONS
Prof. Dr. Mariam Jikia Assoc. Prof. Dr. Kakha Dzagania	Georgian Technical University	ANALYSIS OF RECENT TRANSFORMATIONS IN THE GEORGIAN ELECTORAL SYSTEM
Oladeji Olatunji	Lagos State University	SURVEILLANCE IN THE AGE OF THE INTERNET: THE DEATH OF CIVIL LIBERTY?
Japneet Kaur Kohli Prachi Dembla	Symbiosis Law School	GUN LAWS IN INDIA: AN ANALYSIS
Ph.D Student. Truong Chanh Duc	Regional Political Academy IV	ENSURING FACTORS FOR THE IMPROVEMENT OF LEGAL PROVISIONS REGARDING THE ESTABLISHMENT OF WORKERS' ORGANIZATIONS IN ENTERPRISES IN VIETNAM TODAY
Sirajo Shehu	Federal Polytechnic Kaura Namoda	THE EFFECT OF JOB STRESS ON EMPLOYEE'S PRODUCTIVITY AND COMMITMENT FEDERAL POLYTECHNIC KAURA NAMODA

 DATE	• 23.01.2024	 TIME	• 10⁰⁰–12⁰⁰	 SESSION	• HALL-6 • SESSION-1
--	---------------------	--	--	---	---------------------------------



HEAD OF SESSION: Zohaib Hassan Sain

Mark Anthony N. Polinar Marife O. Templado Sweet Nierelou Saldaña Mary Adeline B. Delos Cientos	Mabolo National High School	BREAKING SILENCE: THE QUALITY OF LIFE, EXPERIENCES, AND CHALLENGES OF BALIK ARAL GRADE 12 STUDENTS
Zohaib Hassan Sain	Superior University	EVALUATING THE EFFECTIVENESS OF PLAGIARISM DETECTION SOFTWARE AS AN EDUCATIONAL TOOL IN ACADEMIC WRITING INSTRUCTION
Zohaib Hassan Sain	Superior University	LEVERAGING CHATGPT FOR EFFICIENT EVALUATION AND FEEDBACK IN THE EDUCATIONAL SETTING
Ananda Majumdar	University of Alberta	EFFECTIVENESS OF DIGITAL LITERACY IN THE CONTEMPORARY ERA
Qufli Osmani Teuta Idrizi Fjolla Veseli	University of Tetova	PREDICTIVE VALUE OF ATTITUDE AND PERCEPTION OF IA AGAINST ACADEMIC SUCCESS OF STUDENTS
Prof. Dr. Safia Urooj Dr. Wahaj Muhammad Khan Dr. Mairaj Muhammad Khan	University of Karachi Literacy Department Govt. of Sindh	IMPACT OF DIGITAL LEARNING FUNDAMENTAL COURSE ON TEACHER'S ONLINE TEACHING AND STUDENTS' LEARNING AT HIGHER LEVEL IN PUBLIC AND PRIVATE SECTOR UNIVERSITIES OF PAKISTAN
Prof. Dr. Safia Urooj Rubina Usman Ali Dr. Wahaj Muhammad Khan Dr. Mairaj Muhammad Khan Farwa Anwar	University of Karachi	IN-SERVICE CONTINUOUS PROFESSIONAL DEVELOPMENT PROGRAM ISSUES AND CHALLENGES IN SINDH PUBLIC SECTOR
Jamsari Alias Norazila Mat Nor Afian Yusof	Universiti Kebangsaan Malaysia.	APPLICATION OF 'JIGSAW' AND 'GALLERY WALK' TECHNIQUES IN INTERACTIVE CLASSROOMS: AN EXPERIENCE OF INNOVATIVE TEACHING AND LEARNING METHOD

	DATE	• 23.01.2024		TIME	• 12³⁰ – 14³⁰		SESSION	• HALL-1 • SESSION-2
---	-------------	---------------------	---	-------------	--	---	----------------	---------------------------------



HEAD OF SESSION: Assoc. Prof. Dr. Mehmet ÜNAL

Dr. Metin YILDIRIM	Ministry of Education	THE WORK CALLED RELIGIOUS AND LITERARY HASBİHALLER, BY ISPARTALI ZEYNELÂBİDİN BEY, AN AUTHOR WHO HAS ESCAPED ATTENTION
Assoc. Prof. Dr. Mehmet ÜNAL Lec. Dr. Halis DEDE	Uşak University	COMPARATIVE CRITICISM OF FAİK REŞAD'S 'TÂRİH-I EDEBİYYÂT-I'OSMÂNİYYE' WITH LATİFİ'S 'TEZKİRETU'Ş-ŞUARÂ'
Lec. Dr. Halis DEDE Assoc. Prof. Dr. Mehmet ÜNAL	Uşak University	GENERAL SYNTAX DISEASES THAT ARE FAMOUS AND FOCUSED ON IN THE ARABIC LANGUAGE
Dr. Mihdat AKTULGA Dr. Nurettin AKCAN	Ministry of Education	THE FIGURE OF 'JESUS THE SAVIOR' IN MANICHEISM
Dr. Mihdat AKTULGA	Ministry of Education	THE IMPORTANCE OF SACRED TIMES IN TERMS OF SIN AND SALVATION IN DUALIST AND MONOTHEIST RELIGIONS
Prof. Dr. Emrullah FATİŞ	Ahi Evran University	THEOLOGICAL PERSPECTIVE ON SOME BELIEF PERCEPTIONS OF SULEIMANISTS
Prof. Dr. Emrullah FATİŞ	Ahi Evran University	CELÂLEDDİN DEVÂNÎ'S APPROACH TO SOME THEOLOGICAL AND PHILOSOPHICAL PERCEPTIONS

		
DATE • 23.01.2024	TIME • 12³⁰ – 14³⁰	SESSION • HALL-2 • SESSION-2



HEAD OF SESSION: Asst. Prof. Dr. Hakan Gökalp TAŞ

Najafgulieva P.H. Gasimov R.Sh.	Azerbaijan Medical University	THE RESULTS OF THE SURGICAL TREATMENT OF PARASTOMAL HERNIAS PERFORMED AT THE AZERBAIJAN MEDICAL UNIVERSITY
Asst. Prof. Dr. Hakan Gökalp TAŞ	Erzincan Binali Yıldırım University	CURRENT APPROACH TO ACCIDENTAL AWARENESS RISK FACTORS DURING GENERAL ANESTHESIA
Isaev H.B. Aliev Yu.D. Kerimova T.A. Isaeva A.N.	Scientific Center of Surgery named after Academician M.A. Topchibashev	THROMBOEMBOLISM OF MESENTERIC VESSELS IS A LIFE-THREATENING COMPLICATION
Assoc. Prof. Dr. Yıldız ERDOĞANOĞLU Ayşen KILINÇER ÇOPUR	Antalya Bilim University	INVESTIGATION OF ANKLE JOINT POSITION SENSE, FUNCTIONAL CAPACITY, AND POSTURAL CONTROL IN INDIVIDUALS WITH PES PLANUS
Duygu Dertli Asst. Prof. Dr. Ayşe Abit Kocaman Assoc. Prof. Dr. Ayla Çağlıyan Türk	Gölcük Necati Çelik State Hospital Kırıkkale University Hitit University	EXAMINATION OF THE RELATIONSHIP BETWEEN BODY IMAGE DISTURBANCE, SPINAL MOBILITY AND QUALITY OF LIFE IN ADOLESCENTS WITH IDIOPATHIC SCOLIOSIS: A PILOT STUDY
Dr. Fzt. Engin RAMAZANOĞLU Assoc. Prof. Dr. Burcu TALU Prof. Dr. Hilal ERMİŞ	Inonu University	A COMPARISON OF THE EFFECTS OF AEROBIC AND HIGH-INTENSITY INTERVAL TRAINING ON FATIGUE AND DISEASE-SPECIFIC QUALITY OF LIFE IN OBSTRUCTIVE SLEEP APNEA

 DATE	• 23.01.2024	 TIME	• 12³⁰ – 14³⁰	 SESSION	• HALL-3 • SESSION-2
--	---------------------	--	--	---	---------------------------------------



HEAD OF SESSION: Prof. Dr. Abdullah E. AKAY

Prof. Dr. Temel SARIYILDIZ	Bursa Technical University	NUTRIENT INPUTS BY LITTERFALL INTO ECOSYSTEMS IN ASH TREE STANDS AT BURSA KARACABEY FORESTED WETLANDS
Prof. Dr. Temel SARIYILDIZ	Bursa Technical University	INVESTIGATION OF LITTER CARBON AND NUTRIENT STOCKS IN ASH TREE STANDS AT BURSA KARACABEY FORESTED WETLANDS
Prof. Dr. Abdullah E. AKAY	Bursa Technical University	EVALUATION OF THE EFFECTS OF FOREST ROAD STANDARDS ON TRANSPORTATION SAFETY
Prof. Dr. Abdullah E. AKAY	Bursa Technical University	USE OF REAL-TIME UAV IMAGES IN SAFE ACCESS TO FIRE AREAS IN THE SHORTEST TIME
Evrım KOZAN Elona HASANİ Güven KAVRAZ Mustafa YILMAZ	Bursa Technical University	THE EFFECTS OF WESTERN CONIFER SEED BUG (LEPTOGLOSSUS OCCIDENTALIS) ON THE SEEDS OF PINE TREES IN TÜRKİYE
Beste Çifçi Nesibe Manav Mutlu Sibel Boran	Nişantaşı University	DIAGNOSIS OF DIABETES WITH DEEP LEARNING
Murat CEYLAN Asst. Prof. Dr. Sibel BORAN Asst. Prof. Dr. Nesibe MANAV MUTLU	Nişantaşı University	PREDICTION MODELING OF STUDENT ACHIEVEMENT USING PREDICTION MODELING TECHNIQUE WITH ARTIFICIAL NEURAL NETWORKS (ANN)
Assistant Professor Recep EKİCİLER	Gazi University	EXPLORING THE POTENTIAL OF FLOW AND HEAT TRANSFER CHARACTERISTICS OF TETRA NANOFLUID (AL ₂ O ₃ -TiO ₂ -Au-Ag/WATER) IN A CHANNEL

 DATE	• 23.01.2024	 TIME	• 12³⁰ – 14³⁰	 SESSION	• HALL-4 • SESSION-2
--	---------------------	--	--	---	---------------------------------------



HEAD OF SESSION: **Prof. Dr. Gürhan Uysal**

Güller BAĞIROVA	Baku State University	INCREASING LOGISTICS RELATIONS BETWEEN AZERBAIJAN AND TURKEY
Asst. Prof. Dr. Arzu Baykara Taşkaya	Dumlupınar University	CHOLERA CASES ON THE ISLAND OF MALTA (1867-1910)
Assoc. Prof. Dr. Gencay KARAKAYA Fatma YILMAZ DAĞNIK	İstanbul Ticaret University	AN OVERVIEW OF THE AUTHORIZED ECONOMIC OPERATOR STATUS IMPLEMENTED WITHIN THE CONTEXT OF TRADE FACILITATION IN TURKEY
Prof. Dr. Gürhan Uysal	Ondokuz Mayıs University	İŞLETMENİN SÜRDÜRÜLEBİLİRLİĞİ: İKY VE İK MATEMATİĞİ
Sema ÖZTÜRK	Nişantaşı University	APPLICABILITY OF CARBON TAX IN TURKEY IN THE FIGHT AGAINST GLOBAL CLIMATE CHANGE
Ömer Gökberk ERBULUT Asst. Prof. Dr. ZEYNEP ÇOLAK	Çanakkale Onsekiz Mart University	SITE SELECTION FOR BRANCH SERVICE BUILDINGS OF BANKS
Esmâ ERTEKİN Assoc. Prof. Dr. Murat YORULMAZ	Kocaeli University	HISTORICAL DEVELOPMENT AND EVALUATION OF TURKISH SHIPPING AGENCY

 DATE	• 23.01.2024	 TIME	• 12³⁰ – 14³⁰	 SESSION	• HALL-5 • SESSION-2
--	---------------------	--	--	---	---------------------------------



HEAD OF SESSION: **Assistant Professor Femmam Manel**

BOUMEDIANE Mounia	Royal Institut of Amazigh Culture	DIGITAL COMMUNICATION AN ASSET FOR DIVERSITY MANAGEMENT: CASE OF THE ROYAL INSTITUTE OF AMAZIGH CULTURE
Faisal ZULHUMADI Amir Hakim MD SANI	Universiti Utara Malaysia	CLOUD STORAGE CONVENIENCE: HOW SATISFIED ARE UUM STUDENTS WITH ITS USAGE?
Assistant Professor Femmam Manel Fareh Mohamed Elkabir	Centre University of Barika University of Biskra	HYBRID GNN-CNN MODEL FOR ALZHEIMER'S DISEASE DETECTION
Associate Professor Dr. Fariza Khalid Dr. Hazrati Husnin Muhammad Irfan Ibrahim	Universiti Kebangsaan Malaysia	INTERACTION PROCESS AMONG POSTGRADUATE STUDENTS IN AN OPEN AND DISTANCE LEARNING PROGRAM FROM THE ACTIVITY THEORY PERSPECTIVE
Ahmad Sawy Khaled Ali Muhammad Noman Saeed	Jazan University,	ENHANCING ACADEMIC EXCELLENCE: A COMPREHENSIVE STUDY OF TRAINING AND DEVELOPMENT IN JAZAN UNIVERSITY THROUGH THE IMPLEMENTATION OF A TRAINING MANAGEMENT SYSTEM DURING THE ACADEMIC YEAR
Okeke Lordwilliams Ikenna Dr. Rasheedul Haque Dr. Farha Zafira binti Agos Lokman	MAHSA University	FACTORS AFFECTING TURNOVER INTENTION OF AN EMPLOYEE IN PRIVATE SECTOR
Deni Darmawan Dinn Wahyudin Alain Kiyindow Eric Omeldo Etien Damome	Universitas Pendidikan Indonesia Bordeaux University-France Universiti Kebangsaan Malaysia	ARTIFICIAL INTELLIGENCE (AI) IN BIO-COMMUNICATION PERSPECTIVE TOWARDS FUTURE VCDLN

 DATE	• 23.01.2024	 TIME	• 12³⁰ – 14³⁰	 SESSION	• HALL-6 • SESSION-2
--	---------------------	--	--	---	---------------------------------



HEAD OF SESSION:

Muhammad Kabiru Abubakar	Hussaini Adamu Federal Polytechnic Kazaure	ISOLATION AND IDENTIFICATION OF FUNGI IN MILLET DOUGH BALLS (FURA) SOLD AT KAZAURE METROPOLIS, JIGAWA STATE, NIGERIA.
Claymon Pool Nur Lyana Syamimi Azman Siti Nurhafifah Azman	Keningau Vocational College	PROMOTING BAKERY & PASTRY PROGRAMME TO THE COMMUNITY VIA OUTREACH ACTIVITIES
KANTAOUI Aicha Pr. BOUDRIES Hafid Dr LARICHE Nesrine	Abd Rahmane mira Bejaia University	PEOPLE'S DEMOCRATIC REPUBLIC OF ALGERIA
Dr. Adama Solomon Bake Muhammed Adamu Zubairu Abdulsalam Rihanat Mohammed Yakubu Mambe Saba Jonathan Jiya	Federal University of Technology Minna Ibrahim Badamasi University Lapai Niger State College of Agriculture Mokwa	A REVIEW: PREVALENCE OF MYCOTOXINS IN DRIED FISH AND FOOD SAFETY IN NIGERIA
Dr. Adama Solomon Bake Muhammed Adamu Zubairu Adegoke Abiola Rhodiyat Mohammed Yakubu Mambe Musa Bulus	Federal University of Technology Minna Ibrahim Badamasi University Lapai	ASSESSMENT OF ARTISANAL MINING ACTIVITIES IN SOME STREAMS/RIVER AROUND MAIWAYO- KATAEREGI AREA IN NIGER STATE, NIGERIA
Salienu Balakrishnan Nur Saff Fiah Aserah Binti Asrah Nur Asyirrah Binti Murshidi	Keningau Vocational College	BRINGING BORNEON FLAVOUR INTO LOCAL DISHERS THROUGH WILD MANGO PASTE
Kennedy Aaron AGUOL	Universiti Malaysia Sabah	LUYANG PRECINCT FOOD SCENE AND PRACTICES: LINKING CONTEMPORARY FOODS AND COMMUNITIES ACTIVITIES TO THE PAST
Amolika Gautam Barinderjit Singh	I. K. Gujral Punjab Technical University	TERMINALIA CHEBULA: BIOACTIVE COMPOUNDS, HEALTH BENEFITS AND THEIR APPLICATION IN FOOD AND PHARMACEUTICAL INDUSTRY

 DATE	• 23.01.2024	 TIME	• 15⁰⁰–17⁰⁰	 SESSION	• HALL-1 • SESSION-3
--	---------------------	--	--	---	---------------------------------------



HEAD OF SESSION: **Asst. Prof. Dr. Halil İbrahim BİNİCİ**

Meryem BAŞATEMÜR Nezihe OTAY LÜLE	Hasan Kalyoncu University Gaziantep University	NUTRITIONAL SUPPLEMENT AFTER BARIATRIC SURGERY
Deniz HAZAR Nezihe OTAY LÜLE	Hasan Kalyoncu University Gaziantep University	NUTRITIONAL SUPPLEMENT IN ELDERLY
Asst. Prof. Dr. Burcu ÇAKMAK SANCAR Asst. Prof. Dr. Meryem AKHAN Asst. Prof. Dr. Başak Gökçe ÇÖL Melikenur TÜRKOL	İstanbul Esenyurt University İstanbul Gelişim University	SUSTAINABLE FOOD TECHNOLOGY APPLICATIONS IN AGRICULTURE AND NUTRITION
Asst. Prof. Dr. Halil İbrahim BİNİCİ	İstanbul Esenyurt University	A NEW FOOD PROCESSING TECHNIQUE: THERMOSONICATION PROCESS
Asst. Prof. Dr. Fitnat Şule ŞAKAR Melikenur TÜRKOL	Halich University	THE ROLE OF WEIGHT MANAGEMENT AND DIETITIAN
Prof. Dr. Enes DERTLİ Göktürk ERİKLİ	Yıldız Technical University	DETERMINATION OF GABA PRODUCTION CAPABILITIES OF LACTOBACILLUS DELBRUECKII SUBSP.BULGARICUS AND STREPTOCOCCUS THERMOPHILUS STRAINS AND FUNCTIONAL YOGURT PRODUCTION
Asst. Prof. Dr. Ali ILGAZ Asst. Prof. Dr. Nesrin TUNCAY	Kapadokya University European University of Lefke	THE ROLE OF SLOW FOOD MOVEMENT IN SUSTAINABLE GASTRONOMY TOURISM
Assoc. Prof. Dr. Ayhan KARAKAŞ Res. Asst. Dr. Ahmet ASLAN Assoc. Prof. Dr. Halim AKBULUT	Bartın University	THE EFFECT OF PERCEIVED ORGANISATIONAL SUPPORT ON ORGANISATIONAL COMMITMENT: A STUDY ON RESTAURANT EMPLOYEES
Assoc. Prof. Dr. Ayhan KARAKAŞ Res. Asst. Dr. Ahmet ASLAN	Bartın University	THE EFFECT OF ORGANISATIONAL MOTIVATION OF FOOD AND BEVERAGE ESTABLISHMENTS EMPLOYEES ON THEIR PERFORMANCE

		
DATE • 23.01.2024	TIME • 15⁰⁰-17⁰⁰	SESSION • HALL-2 • SESSION-3



HEAD OF SESSION: Res. Asst. Okan GÜDER

Büşra YÜKSEL	Ankara Yıldırım Beyazıt University	INTRODUCTION OF ARTIFICIAL INTELLIGENCE AND THE ROLE OF AI APPLICATIONS IN TURKISH AEROSPACE AND DEFENSE INDUSTRY
Berna SOYSAL Sefer BADAY	Istanbul Technical University	PREDICTION OF CHONDROITIN COMPETITIVE SULFOTRANSFERASE ENZYME INHIBITORS FOR THE TREATMENT OF ALZHEIMER'S DISEASE
Bünyamin ÖZER Lec. Dr. Sevinç Ay Assoc. Prof. Dr. Derya AVCI	Fırat University	BRAIN TUMOR CLASSIFICATION WITH DECISION SUPPORT SYSTEMS
Res. Asst. Okan GÜDER Asst. Prof. Dr. Yasemin ÇETİN KAYA	Tokat Gaziosmanpaşa University	CLASSIFICATION OF SKIN LESIONS
Merve BALABAN Res. Asst. Dr. Gökhan UÇAR Assoc. Prof. Dr. Emre DANDIL	Bilecik Şeyh Edebali University	AUTOMATED DETECTION OF ISCHEMIC STROKE LESIONS USING U-NET DEEP LEARNING ARCHITECTURE IN BRAIN MR SCANS
Sedat BAYARAL Lec. Dr. Sevinç AY Assoc. Prof. Dr. Derya AVCI	Fırat University	DETECTING HEART DISEASE USING MACHINE LEARNING MODELS
Hamit FIRAT Assoc. Prof. Dr. Derya AVCI	Fırat University	BITCOIN PRICE PREDICTION USING ARTIFICIAL INTELLIGENCE ALGORITHMS
Tuğrul YAĞBASAN Hayati TÜRE Metehan Murad TALİ	Giresun University Gümüşhane University Kocaeli University	IOT SECURITY WITH ELASTIC STACK AND MACHINE LEARNING: INTELLIGENT DEFENCE SYSTEM AGAINST DOS ATTACKS

 DATE	• 23.01.2024	 TIME	• 15⁰⁰–17⁰⁰	 SESSION	• HALL-3 • SESSION-3
--	---------------------	--	--	---	---------------------------------------



HEAD OF SESSION: **Res. Asst. İrem ARSLANTÜRK**

Nurse Serda DURMUŞ KELEŞ Assoc. Prof. Dr. Gülzade UYSAL	İstanbul Kanuni Sultan Süleyman Training and Research Hospital Sakarya University of Applied Sciences	A CHILD WITH ACUTE DISSEMINATED ENCEPHALOMYELITIS AND NURSING CARE: CASE REPORT
Nurse Serda DURMUŞ KELEŞ Assoc. Prof. Dr. Gülzade UYSAL	İstanbul Kanuni Sultan Süleyman Training and Research Hospital Sakarya University of Applied Sciences	TECHNOLOGY ADDICTION IN CHILDREN
Meltem KARAHAN Assoc. Prof. Dr. Bahar Başak KIZILTAN ELİAÇIK	University of Health Sciences	DO COLORS AND MUSIC HAVE AN IMPACT ON DENTAL ANXIETY?
Asst. Prof. Dr. Serpil ALLUŞOĞLU Tuğba Nur CİVİL	İzmir Bakırçay University	THE EFFECT OF ODOR ON HEARING IN NOISE ABILITY IN INDIVIDUALS WITH NORMAL HEARING IN NOISY ENVIRONMENTS
Erg. Elif ORHAN Erg. Aleyna AYTEKİN Prof. Dr. Hülya KAYIHAN Lec. Remziye AKARSU	Biruni University	EFFECT OF PROGRESSIVE MUSCLE RELAXATION TRAINING ON OCCUPATIONAL PERFORMANCE IN CHILDREN IN CHILDREN'S HOUSE
Assistant Professor Dr. Bayram Sönmez ÜNÜVAR	KTO Karatay University	THE CONTENT QUALITY AND READABILITY OF THE PATIENT INFORMATION TEXTS ON TURKISH WEBSITES REGARDING EXERCISES FOR LOWER BACK PAIN
Res. Asst. İrem ARSLANTÜRK Res. Asst. Sena Nur BAŞARAN	Ağrı İbrahim Çeçen University	THE IMPORTANCE OF INFLAMMATORY MARKERS IN THE DIAGNOSIS OF BRUCELOSIS
L.I. Rustamova F.H. Heydarova S.M. Mammadov N.M. Atakishiyeva A.S. Ismayilova C.M. Aliyeva	The Scientific-Research Institute of Medical Prevention named after V.Y. Akhundov	CHICKEN POX INFECTION IN BAKU DURING THE COVID-19 PANDEMIC SPREADING

		
DATE	TIME	SESSION
• 23.01.2024	• 15⁰⁰-17⁰⁰	• HALL-4 • SESSION-3



HEAD OF SESSION: **Res. Asst. Dr. Oğulcan AVCI**

Sümeyye DİLMEN Assist. Prof. Murat ŞAHİN Assist. Prof. Muhammet KURUCU	Fırat University	EVALUATION OF THE PLANS OF GRAND MOSQUES OF THE ARTUKLU PERIOD USING THE FRACTAL ANALYSIS METHOD
Göksu KUNT Asst. Prof. Dr. Halil SEVİM	KTO Karatay University	MATERIAL SELECTION IN INTERIOR DESIGN OF HEALTHCARE BUILDINGS
Nafise SHOJA Yağmur BEYTEKİN	Bursa Uludag University	INVESTIGATION OF SUSTAINABLE CONSTRUCTION TECHNIQUES AND ENERGY EFFICIENT BUILDING DESIGN PRINCIPLES IN HEALTHY CITIES: AN ANALYSIS OF BUILDING DESIGNS
Asena Seda ÇOBAN Asst. Prof. Dr. Türkan Nihan HACIÖMEROĞLU	Eskişehir Osmangazi University	THE ANALYSIS OF SACRED SPACES WITHIN THE CONTEXT OF ARCHITECTURE AND BELIEF SYSTEMS
Muhammet KOCAMAN	Ahi Evran University	CURRENT SITUATION OF OLTU STONE CARVING, A TRADITIONAL TURKISH CRAFT
Res. Asst. Dr. Oğulcan AVCI Asst. Prof. Dr. Nurcan BOŞDURMAZ	Giresun University İstanbul Bilgi University	A SECTION FROM THE HISTORICAL PROCESS OF ANADOLU HİSARI FATİH SULTAN MEHMED MOSQUE IN CONSIDERATION OF ARCHIVE DOCUMENTS
Hatice Kübra GÜNDÜZ Asst. Prof. Dr. Meltem ERBAŞ ÖZİL	Dicle University	EVALUATION OF DIYARBAKIR KINDERGARTEN WITHIN THE SCOPE OF MONTESSORI METHOD SPATIAL PRINCIPLES
Yunus Emre GÜNDOĞAN Asst. Prof. Dr. Umut ALMAÇ	İstanbul Technical University	EKIRDAG INONU MIDDLE SCHOOL: CURRENT STATE, CONSERVATION ISSUES AND PROPOSALS

 DATE	• 23.01.2024	 TIME	• 15⁰⁰–17⁰⁰	 SESSION	• HALL-5 • SESSION-3
--	---------------------	--	--	---	---------------------------------



HEAD OF SESSION: **Dr. Moses Adeolu AGOI**

HUMA RAJPUT	ISTANBUL AYDIN UNIVERSITY	THE EFFECTS OF EMPLOYEE PERCEPTION S ABOUT TRAINING ON THEIR PERFORMANCES
MUHAMMAD FAISAL	Allama Iqbal Open University	THE PRINCIPAL STEP FOR ADVANCE THE SOCIAL AND CONDUCT CHANGE CORRESPONDENCE WITH MORALITY IN PAKISTAN
Profa. Dra. Maria Emilia Camargo Profa. Dra. Mariane Camargo Priesnitz Prof. Dr. Walter Priesnitz Filho Profa. Dra. Rosecler Maschio Gilioli Profa. Dra. Angela Isabel dos Santos Dullius	Federal University of Santa Maria University of Caxias do Sul	IMPACT OF ORGANIZATIONAL CULTURE ON THE TECHNOLOGICAL INNOVATION PROCESS MEDIATED BY KNOWLEDGE MANAGEMENT
Profa. Dra. Maria Emilia Camargo Profa. Dra. Mariane Camargo Priesnitz Profa. Dra. Rosecler Maschio Gilioli Profa. Dra. Angela Isabel dos Santos Dullius Profa. Dra. Angela Pelegrin Ansuji	Federal University of Santa Maria University of Caxias do Sul	RELATIONSHIP BETWEEN INTELLECTUAL CAPITAL AND ORGANIZATIONAL PERFORMANCE
Mohammed Mohammed Ndagi Dauda Adamu Abubakar Ibrahim Abdulrahman Habiba Muhammad Enag	Ahmadu Bello University Nigeria Institute of leather and Science Technology Galaxy Memorial Islamic School Minna Usman Danfodio University Sokoto	IMPACT OF N-POWER SOCIAL INVESTMENT SKILLS ACQUISITION PROGRAMMES ON YOUTH EMPOWERMENT IN NIGER STATE
Moses Adeolu AGOI Oluwanifemi Opeyemi AGOI	Lagos State University of Education Obafemi Awolowo University	THE ROLE OF TECHNOLOGY AS AN ANTI-TRAFFICKING TOOL AND ITS EFFECT ON GLOBAL SOCIETY
Msc Arben Bici Prof.Dr. Agron Kasa	University of Sport of Tirana	EFFECTS OF DIFFERENT HIGH-INTENSITY INTERVAL TRAINING WITH COD RUNNING ON AEROBIC AND ANAEROBIC CAPACITY IN 16-YEAR-OLD SOCCER PLAYERS

 DATE	• 23.01.2024	 TIME	• 15⁰⁰–17⁰⁰	 SESSION	• HALL-6 • SESSION-3
--	---------------------	--	--	---	---------------------------------------



HEAD OF SESSION: Sirhajwan Idek

Claijester Christian Nadiirah Naquyyah Alleyston Voo	Keningau Vocational College	TRASH COLLECTING FLOATING FARM
Hassan Abdulmumini	Federal polytechnic Bali	EFFECTS OF PHOSPHATE FERTILIZER ON GROWTH AND YIELD OF SOYA-BEAN (GLYCINE MAX)
OBIORA DOREEN CHNONSO	University of Nigeria	RISK MANAGEMENT STRATEGIES AMONG GARDEN EGG FARMERS IN ENUGU STATE, NIGERIA
Olesya REVTO Dmytro OSTAPENKO	Kherson State Agrarian and Economic University	MINIMIZING THE TILLAGE OF THE SOIL AS A FACTOR INCREASING THE PRODUCTION OF AGRICULTURAL PRODUCTS UNDER THE CONDITIONS OF CLIMATE CHANGE
Nataliia LAVRENKO Alexei SAFONOV	Kherson State Agrarian and Economic University	STRATEGIC GOALS OF RAISING THE STANDARD OF LIVING AND DEVELOPMENT OF AGRICULTURE IN RURAL AREAS OF UKRAINE
Olatoye, F.C. Oladimeji, Y. U. Sanni, S. A. Abdulkadir, A.	Ahmadu Bello University	ANALYSIS OF FARM HOUSEHOLDS' PRODUCTIVITY ON IDENTIFIED AGROFORESTRY PRACTICES IN OYO STATE, NIGERIA
Muhammad Aminu Musa Bashir Muhammad Ashir	Ahmadu Bello University	EVALUATING THE EFFECTS OF VARIOUS COOLING TECHNIQUES ON ENERGY EFFICIENCY OF LIBRARIES IN HOT AND DRY CLIMATE OF NIGERIA
Maina, M. Oladimeji, Y. U. Hussaini, A.S. Abdulrahman S. Shuaibu, H.	Ahmadu Bello University	ANALYSIS OF DIRECTION OF PRICE TRANSMISSION AND COMPETITIVENESS AMONG FERTILIZER VALUE CHAIN ACTORS IN KADUNA STATE, NIGERIA

 DATE	• 24.01.2024	 TIME	• 10⁰⁰–12⁰⁰	 SESSION	• HALL-1 • SESSION-1
--	---------------------	--	--	---	---------------------------------------



HEAD OF SESSION: **Asst. Prof. Dr. Mehmet Salih NAS**

Lec. Dr. Yusuf Gökhan DURSUN	Aksaray University	EVALUATION OF NİTRİTE (NO 2) AND NİTRATE (NO 3) POLLUTION PARAMETERS OF GROUNDWATER IN ESKİL (AKSARAY) REGION
Sena ÖZDİL Sema SAMATYA YILMAZ Assoc. Prof. Dr. Merve DANDAN DOĞANCI Assoc. Prof. Dr. Erdinç DOĞANCI	Kocaeli University	PREPARATION OF TETRA-N-BUTYLAMONIUM HYDROGEN SULFATE QUATERNARY AMMONIUM SALT ADDED ANTIBACTERIAL EFFECTIVE WOUND DRESSING
b.ü.f.d.,dos.S.Ş.Məmmədov Jahan Siraj gizi Mammadova	Academy of Labor and Social Relations Azerbaijan State Pedagogical University	FACTORS AFFECTING THE FORMATION OF MODERN LANDSCAPES OF THE SOUTHEASTERN PART OF THE GREATER CAUCASUS
Asst. Prof. Dr. Mehmet Salih NAS	Iğdır University	PREPARATION OF MWCNT/WO 3 /PPy NANOCATALYST FOR SONOCATALYTIC DEGRADATION OF METHYLENE BLUE
Research Assistant Kaan YEŞİLOVA Assist. Prof. Dr. Özgün YÜCEL Başak TEMUR ERGAN	Gebze Technical University	MACHINE LEARNING ON PHYSICAL PROPERTIES OF TERNARY BLENDS VIA COMPOSITON AND TEMPERATURE RATE
Burcu ÇANAK Assoc. Prof. Dr. Uğur MORALI Prof. Dr. Hakan DEMİRAL	Eskişehir Osmangazi University	COMPUTATIONAL INVESTIGATION OF THE MAXIMUM BATTERY TEMPERATURE OF A COMMERCIALY AVAILABLE LITHIUM ION BATTERY
Batuhan ZEYREK Assoc. Prof. Dr. Erdinç DOĞANCI Assoc. Prof. Dr. Merve DANDAN DOĞANCI	Kocaeli University	OBTAINING THERMOPLASTIC COPLIESTER ELASTOMER (TPE) SURFACES AND EXAMINING THEIR FREE SURFACE ENERGIES
Asst. Prof. Dr. Şeyda Çiğdem ÖZKAN KÖÇ Tülin BURHANOĞLU Asst. Prof. Dr. Zehra Seda HALBUTOĞULLARI Prof. Dr. Yusufhan YAZIR Prof. Dr. Aydan YILMAZ	Nevşehir Hacı Bektaş Veli University Gebze Technical University Kocaeli University Selçuk University	SYNTHESIS OF SOME WATER-SOLUBLE CALIX[4]ARENES AND INVESTIGATION OF THEIR ANTICANCER PROPERTIES

 DATE	• 24.01.2024	 TIME	• 10⁰⁰–12⁰⁰	 SESSION	• HALL-2 • SESSION-1
--	---------------------	--	--	---	---------------------------------------



HEAD OF SESSION: Dr. Malak Karimova Feruz kızı

Malak Karimova Feruz kızı	Khazar University	THE ROLE OF MUSIC THERAPY IN OUR MENTAL WELL-BEING
Melis Öz Assoc. Prof. Dr. Sernaz Demirel Temel	Yıldız Technical University	THE ROLE OF WOMAN AS SANGERS AND THE EXAMPLE OF AMELYA KADRIYE
Dr. Bilge Özkaymak	Selçuk University	PASSIONATE TANGO MADE BY VISUALITY WITH TASTE: MARKIZ (LEBON) PATISSERIE
Asst. Prof. Dr. Hüseyin PARPUCU Asst. Prof. Dr. Cihan Ünver ÇABUK	Karamanoğlu Mehmetbey University	AN ANALYSIS OF THE QUOTAS OF DEPARTMENTS IN HIGHER EDUCATION INSTITUTIONS PROVIDING EDUCATION IN THE FIELD OF MUSIC
Asst. Prof. Dr. Hayri AĞAN	Mimar Sinan Fine Arts University	A SPACE FOR THE VISIBILITY OF YOUNG ARTIST CANDIDATES: BASE 2023 IN THE CONTEXT OF PAINTING
Hasan Ceyhun CAN Yaren KASAPÖĞLU Şule Azra AKBULUT	İstanbul University-Cerrahpaşa	HOW DOES READING BOOKS HAVE AN EFFECT ON THE COMPETENCIES OF PROSPECTIVE PHYSICAL EDUCATION TEACHERS?: A MIXED METHOD RESEARCH
Research Assistant Hüseyin Ertan İNAN	Ondokuz Mayıs University	EVALUATION OF SERVICE QUALITY IN FITNESS CENTERS: ANALYTIC HIERARCHY PROCESS APPROACH

 DATE	• 24.01.2024	 TIME	• 10⁰⁰–12⁰⁰	 SESSION	• HALL-3 • SESSION-1
--	---------------------	--	--	---	---------------------------------



HEAD OF SESSION: Asst. Prof. Dr. Esra ARSLAN YÜKSEL

Muhammed Safa ÇELİK Assoc. Prof. Dr. Serap ÇETİNKAYA	Sivas Cumhuriyet University	PRODUCTION AND CHARACTERIZATION OF LACCASE ENZYME FROM ENVIRONMENTAL BACILLUS ISOLATES
Asst. Prof. Dr. Özlem Türksöy Terzioğlu	University of Health Sciences	SPHEROID CULTURE SYSTEM METHODS AND CURRENT DEVELOPMENTS
Ege Arda YÜKSEL	Biruni University	EFFECT OF JUGLONE ON ALLELOPATHY AND GENE EXPRESSION
Umur Tuğcu YILMAZER Res. Asst. Elif Naz GÜRSOY Prof. Dr. Şule COŞKUN CEVHER	Gazi University	THE EFFECT OF MORIN AND HESPERIDIN COMBINATION ON PROTEIN DYSFUNCTION IN STREPTOZOTOCIN (STZ)-INDUCED EXPERIMENTAL ALZHEIMER'S MODEL
Asst. Prof. Dr. Neslihan Mutlu	Kafkas University	CHITOSAN IN MICROBIAL BIOTECHNOLOGY: MULTIFACETED APPLICATIONS AND SUSTAINABLE SOLUTIONS
Yasemin MUTLU Asst. Prof. Dr. Kaan HÜRKAN Assoc. Prof. Dr. Yakup Erdal ERTÜRK	Iğdır University	EVALUATION OF HIGH SCHOOL STUDENTS' ATTITUDES TOWARDS BIOTECHNOLOGY: THE CASE OF AĞRI PROVINCE
Asst. Prof. Dr. Esra ARSLAN YÜKSEL	Atatürk University	ESTIMATION OF ALLEVIATIVE EFFECT OF TANNIC ACID ON GENOMIC INSTABILITY IN CHROMIUM-TREATED ZEA MAYS
Damad Adnan MOHAMMED Prof. Dr. Murat KÜTÜK Assoc. Prof. Dr. Mehmet YARAN Res. Asst. Esra ATACAN DOĞAN	Gaziantep University	RESEARCH ON FRUIT FLY (DIPTERA: TEPHRITIDAE) FAUNA AND SYSTEMATICS OF ELAZIG PROVINCE

 DATE	• 24.01.2024	 TIME	• 10⁰⁰-12⁰⁰	 SESSION	• HALL-4 • SESSION-1
--	---------------------	--	--	---	---------------------------------------



HEAD OF SESSION: **Asst. Prof. Dr. Aylin BİLGİN**

Güllü YAZKAN Prof. Dr. Nezihe BULUT UĞURLU Assoc. Prof. Dr. Fatma BİRGİLİ Feyza ACAR	Mugla Sıtkı Koçman University Mugla Training and Research Hospital	PSİKOSTİMÜLAN MADDELER VE PSİKOSOSYAL HEMLİRELİK BAKIMI
Güllü YAZKAN Prof. Dr. Nezihe BULUT UĞURLU Assoc. Prof. Dr. Fatma BİRGİLİ Feyza ACAR	Mugla Sıtkı Koçman University Mugla Training and Research Hospital	ANTİPSİKOTİK İLAÇLARIN YAN ETKİLERİNDEN EKSTRAPİRAMİDAL SENDROM VE HEMŞİRELİK BAKIMI
Fzt. Süleyman Tark Gül	Antalya Bilim University	BIOPSYCHOSOCIAL INVESTIGATION OF THE EFFECT OF THE PANDEMIC ON THE PHYSICAL ACTIVITY AND LIFE HABITS OF YOUNG ADULTS DURING THE NORMALIZATION PERIOD AFTER THE COVID19 PANDEMIC PROCESS
Hilal ÖZCAN	İstanbul Sabahattin Zaim University	A FILM REVIEW IN THE CONTEXT OF PSYCHOANALYTIC THEORY: WHERE THE WILD THINGS ARE
Assoc. Prof. Dr. Erkan DİKİCİ Necla KARA	Bitlis Eren University	PSYCHOSOCIAL ASSESSMENT OF RETURN OF DUTY PERSONNEL
Res. Asst. Öznur ÇINAR	Bayburt University	EVALUATION OF PSYCHOSOCIAL ACTIVITIES APPLIED AFTER 2023 KAHRAMANMARAŞ EARTHQUAKES
Res. Asst. Öznur ÇINAR	Bayburt University	MONITORING THE CONCEPTUAL RESEARCH OF FLOOD AND TORRENT EVENTS
Ayşenur DAYAN Banu TERZİ	Antalya Bilim University Akdeniz University	THE EFFECT OF USING VIRTUAL REALITY IN TEACHING BASIC NURSING SKILLS ON STUDENTS' KNOWLEDGE, SENSORY AND PSYCHOMOTOR SKILLS: A SYSTEMATIC REVIEW
Asst. Prof. Dr. Aylin BİLGİN	Sakarya University of Applied Sciences	DETERMINING THE RELATIONSHIP BETWEEN GASTROINTESTINAL SYMPTOMS AND COMFORT IN INFLAMMATORY BOWEL PATIENTS

 DATE	• 24.01.2024	 TIME	• 10⁰⁰–12⁰⁰	 SESSION	• HALL-5 • SESSION-1
--	---------------------	--	--	---	---------------------------------------



HEAD OF SESSION: Dr. Chems Eddine BOUKHEDIMI

Msc Iva SULAJ	“Aleksandër Moisiu” University Logos University College	PRICING TO MARKET AS A TOOL OF COMPETITION. A BRIEF OVERVIEW.
Zulfatus Saroya Anisa Kamila Tri Ayu Widyastuti Achmad Tubagus Surur Muhammad Sultan Mubarak	UIN. KH. Abdurrahman Wahid Pekalongan	ISLAMIC ECONOMY WITH ITS GOAL AS A BENEFIT OF MANKIND IN INDONESIA
Senior Research Fellow Radoslav Baltezarević Associate Professor Ivana Baltezarević	Institute of International Politics and Economics Megatrend University	THE MACROECONOMIC ADVANTAGES OF HIGH- QUALITY EDUCATION
Dr. Chems Eddine BOUKHEDIMI	University of Tizi Ouzou	MEASURING THE NEXUS BETWEEN E-SATISFACTION AND E-LOYALTY IN ALGERIA
Haikal Nur Ain binti Zulkifflee Siti Nur Asyira binti Azhar Nur Syazana binti Suhaimi Herman Shah ANUAR	Universiti Utara Malaysia,	HALAL SUPPLY CHAIN MANAGEMENT IN FROZEN FOOD INDUSTRY: ISSUES AND CHALLENGES IN NORTHERN KEDAH
Tan Jin Soon KYLE Herman Shah ANUAR	University Utara Malaysia	JOB SATISFACTION AMONG YOUTH IN MALAYSIA OIL AND GAS INDUSTRY
Ijeoma C. Ogonnaya	University of the Free State	TOPIC-SPECIFIC NATURE OF PEDAGOGICAL CONTENT KNOWLEDGE INTEGRATION IN THE TEACHING OF DYNAMICS OF MARKET
Muhammad Ammar Bin Norman Mohd Kamarul Irwan Abdul Rahim	Universiti Utara Malaysia	OPTIMIZATION OF TRANSPORTATION PROBLEM IN POS LAJU MALAYSIA

 DATE	• 24.01.2024	 TIME	• 10⁰⁰–12⁰⁰	 SESSION	• HALL-6 • SESSION-1
--	---------------------	--	--	---	---------------------------------



HEAD OF SESSION: **Dr. Sándor FÖLDVÁRI**

Есенгельдиева Сауле Мергентаевна	Korkyt Ata Kyzylorda University	HISTORY AND DESIRE: AHMET BAITURSYNOV'S LITERARY WORLD
Dr. Natela Borisovna POPKHADZE	Scholarly Information Center at Phassis Academy	SCIENTIST BURIED IN 1837 IN KIEV'S SANTA SOPHYA LAURA/MONASTERY THAT WROTE AND PUBLISHED A GOOD BOOK ABOUT MY COUNTRY SAKARTVELO/ GEORGIA/ KOLKHETI/ GRUZIA IN LEIPZIG IN 1804
Sándor FÖLDVÁRI, dr.	Debrecen University	HOW FAR THE BOOK TRADE REACHED: INTER-CULTURAL CONTACTS BETWEEN THE GRAND DUCHY OF LITHUANIA AND THE HUNGARIAN KINGDOM
Favour C. Uroko	University of Nigeria	PSALM 14:1–7 AND CORRUPTION IN NIGERIA
AMINU MAIKUDI	FEDERAL UNIVERSITY DUTSINMA	ISLAMIC SYSTEM OF LABOUR RELATION (IJARAH) AND ITS IMPACT ON THE DEVELOPMENT OF PRIVATE SCHOOLS IN KATSINA STATE
AISYAH AMINI ZAKIYAH MUBAROK MUHAMMAD SULTAN MUBAROK	Islamic University K.H Abdurrahman Wahid Pekalongan	EXPORATION OF THE VALUES OF MONOTHEISM IN THE FINANCIAL STATEMENTS OF ISLAMIC BANKING INSTITUTIONS
Svitlana Hanaba	National Academy of the State Border Guard Service of Ukraine named after Bohdan Khmelnytskyi	ANTIFRAGILITY AS THE BASIS OF THE DEVELOPMENT OF THE MODERN WORLD
HOUNDJI Pamphile AGOSSA Toussaint	Université d'Abomey-Calavi	PERI-URBAN DYNAMICS IN THE OUEDO DISTRICT IN BENIN

		
DATE • 24.01.2024	TIME • 12³⁰–14³⁰	SESSION • HALL-1 • SESSION-2



HEAD OF SESSION: **Asst. Prof. Dr. İlkay ÜNAL**

Okan DİNÇ Ramazan Furkan KOCA	Koluman Otomotiv Endüstri A.Ş. Karabük Üniversitesi	HIGH EFFICIENCY LIQUID FUEL HEATING SYSTEMS IN DEFENCE INDUSTRY
Emilya ŞÜKÜROVA	Baku State University	CURRENT SITUATION OF DEMAND AND CONSUMPTION OF CANNING INDUSTRY PRODUCTS IN AZERBAIJAN
Asst. Prof. Dr. Fatih YIGIT	Altınbaş University	MULTI-CRITERIA INVENTORY CLASSIFICATION USING METAHEURISTICS AND IMPORTANCE OF CONSTRAINT AND VETO PRINCIPLES
Gachay Aliyev Huseynali oghlu Sevinj Ibrahimova Amrahqızı	Azerbaijan State Pedagogical University	METHODS OF JOINING WOOD PRODUCTS. STAND PREPARATION TECHNOLOGY
Res. Asst. Dr. Gamze GÖKTEPELİ Prof. Dr. Esra YEL	Konya Technical University	EFFECT OF CATALYTIC PYROLYSIS CHAR ON POLYPROPYLENE HYBRID COMPOSITES
Res. Asst. Dr. Gamze GÖKTEPELİ	Konya Technical University	EFFECT OF DIFFERENT PRE-TREATMENTS ON THERMAL PROPERTIES OF SUNFLOWER SEED HUSK HYDROCARBS
Asst. Prof. Dr. İlkay ÜNAL Res. Asst. Dr. Burcu AYDOĞDU	Munzur University	EVALUATION OF STRUCTURAL PROPERTIES OF HYDROXYAPATITES SYNTHESIZED THROUGH DIFFERENT MODIFICATIONS

 DATE	• 24.01.2024	 TIME	• 12³⁰ – 14³⁰	 SESSION	• HALL-2 • SESSION-2
--	---------------------	--	--	---	---------------------------------



HEAD OF SESSION: **Asst. Prof. Dr. Seda ÇELİK**

M. Ismail BAZZAZ Res. Asst. Dr. Sümeyye KOÇ Prof. Dr. Kansu BÜYÜKAFŞAR	Mersin University	MEASUREMENT OF NEUROPEPTIDE LEVELS RELEASED BY MOTOR NERVE STIMULATION FROM ISOLATED RAT HIND LIMB VASCULAR BED
Aziz Kürşat KILIÇDAĞI Fikriye YALÇINKAYA Derya BAYRAKTAR Ahmet Sencer YURTSEVER Kansu BÜYÜKAFŞAR	Mersin University	THE POSSIBLE ROLE OF THE GPER-1 RECEPTOR IN THE DIET-ORIENTED ESTROGENIC SUBSTANCES AND ADIPOGENIC EFFECTS
Asst. Prof. Dr. Seda ÇELİK	Ağrı İbrahim Çeçen University	THE ROLE OF INFLAMMATION IN CORONARY ARTERY DISEASE
Asst. Prof. Dr. Oğuzhan TUĞRUL Asst. Prof. Dr. Seda ÇELİK	Ağrı İbrahim Çeçen University	CARDIOVASCULAR SYSTEM DISEASES and COVID-19
Dr. Selda KARADAĞ Prof. Dr. Turgut KIRMIZIBAYRAK	Kafkas University	GOOSE AS AN INCREASINGLY POPULAR POULTRY IN TÜRKİYE
Assoc. Prof. Dr. İlker ŞEN Nazlı BÜYÜKYILDIZ M. Akif ÇATAK	Sivas Cumhuriyet University	TREATMENT OF TEMPOROMANDIBULAR JOINT LUXATION IN A CAT: CASE REPORT
Sezgin DÜZCE Prof. Dr. Duygu SÖNMEZ DÜZKAYA Assoc. Prof. Dr. Atiye KARAKUL	Tarsus University	EARLY MOBILIZATION IN THE PEDIATRIC INTENSIVE CARE UNIT
İrem AKOY Prof. Dr. Duygu SÖNMEZ DÜZKAYA Assoc. Prof. Dr. Atiye KARAKUL	---	PREVENTIVE AND REHABILITATIVE NURSING CARE FOR RESPIRATORY SYSTEM DISEASES IN CHILDREN

 DATE	• 24.01.2024	 TIME	• 12³⁰ – 14³⁰	 SESSION	• HALL-3 • SESSION-2
--	---------------------	--	--	---	---------------------------------



HEAD OF SESSION: **Asst. Prof. Dr. Dilek Özlem ESEN**

Ph.D Nazila Ragimova Kamenieva Nina Almammadova Mehriban	Azerbaijan State Oil and Industry University Ukrainian State University of Railway Transport	PERSONNEL OF AUTOMATED CONTROL SYSTEMS WITH THE PURPOSE OF IMPROVING AND INCREASING THE RELIABILITY OF THE SYSTEMS IN CONSIDERATION DURING THEIR DESIGN
Asst. Prof. Dr. Dilek Özlem ESEN Murat YÜCEL	Kocaeli University	THEORETICAL INVESTIGATION OF THE EFFECT OF THE USE OF BIOFUELS IN DIESEL ENGINES ON ENGINE PERFORMANCE AND EMISSIONS
Bekir Can ÇIBUK İbrahim Can AYDIN Vural AKTÜRK	Ulaşım İç ve Dış Ticaret Anonim Şirketi	APPLICATION OF THE TOWING SYSTEM TO THE LF12 VEHICLE
Bekir Can ÇIBUK İbrahim Can AYDIN Ahmet ÖZCAN	Ulaşım İç ve Dış Ticaret Anonim Şirketi	IMPLEMENTATION OF LF25 METROBUS VEHICLE DRIVER SAFETY BELT CONNECTION WITHIN THE SCOPE OF R14 REGULATION
Prof. Dr. Gökçe Çiçek CEYHUN	Bursa Technical University	POSSIBLE EFFECTS OF DECARBONIZATION PRACTICES IN THE MARITIME INDUSTRY ON MARITIME TRADE
Talat Taha GÖKÇE Oğuzhan ARI	Ulaşım İç ve Dış Tic. A.Ş.	LF12 VEHICLE E-MIRROR APPLICATION
Osman İlker AÇIKGÖZ Asst. Prof. Selim TANGÖZ	Erciyes University	FAN BLADE BALANCING ON AIRCRAFT ENGINES AND ITS APPLICATION ON CF6 ENGINES

		
DATE • 24.01.2024	TIME • 12 ³⁰ –14 ³⁰	SESSION • HALL-4 • SESSION-2



HEAD OF SESSION: Prof. Dr. Muhittin Eliaçık

Eda EYİ	Ardahan University	THE METHOD OF VERIFICATION TURKISH LANGUAGE: ON THE BENEFITS OF TEACHING TURKISH GRAMMAR WITH 'OKLAMA'
Eda EYİ	Ardahan University	THE EFFECTS OF CHANGING AND NOT CHANGING THE ALPHABET ON TURKISH SOCIETY
Kübra DİNÇSOY	Kırıkkale University	ON THE WORK OF AHMED BİN ABDÜ'L-CEBBÂR'S TUHFETÜ'L-MÜLÛK
Prof. Dr. Muhittin Eliaçık	Kırıkkale University	A COMPILATION ON WORDS OF HAZRAT ALI
Prof. Dr. Muhittin Eliaçık	Kırıkkale University	VERSE CATECHISM TEXT BY AN UNKNOWN AUTHOR
Prof. Dr. Mustafa KARABULUT	Adıyaman University	NECİP FAZIL KISAKÜREK'S CONTRIBUTIONS TO TURKISH
Prof. Dr. Mustafa KARABULUT	Adıyaman University	EDİP CANSEVER'S CONTRIBUTIONS TO TURKISH
TUBA ÇETOK	Muğla Sıtkı Koçman University	TRANSFORMATION OF THE NARRATED WOMAN INTO THE NARRATING WOMAN: THE STORY OF UNACCEPTABLE FEMININITY IN THE NOVEL YUSUF İLE ZÜLEYHA

 DATE	• 24.01.2024	 TIME	• 12³⁰ – 14³⁰	 SESSION	• HALL-5 • SESSION-2
--	---------------------	--	--	---	---------------------------------------



HEAD OF SESSION: Dr. Hassan Bouhsiss

Meeta Saxena	Sophia College (Autonomous)	EFFECT OF RADIATION ON OPTICAL, ELECTRICAL AND STRUCTURAL CHARACTERIZATION OF MNA DOPED PS: PVS POLYBLENDS
Hassan Bouhsiss A. En-Naji Abdelkrim Kartouni M. El Ghorba	Hassan II University Moulay Ismail University	SINGLE NOTCH EFFECT IN TENSILE PLATES
Andrey Popatanasov Luybka Tancheva Reni Kalfin	Bulgarian Academy of Sciences	BIOPHYSICAL MODELLING OF THE NEUROTENSIN RECEPTORS NTS1 IN RATTUS NORVEGICUS AND MUS MUSCULUS
KACI Cilya ARKOUB-DJERMOUNE Lynda BOULEKBACHE-MAKHLOUF Lila	Bejaia University	NUTRITIONAL PROPERTIES AND BENEFICIAL HEALTH EFFECTS OF MELON SEEDS (CUCUMIS MELO L.)
GUERBOUB Lynda SOUFI Ouahiba Lynda OULDSAADI	Université de Bejaia	EXTRACTION OF BIOACTIVE COMPOUNDS FROM OLIVE POMACE
Sadaf Fatima Sunil Yadav	V. K. S. Univ. Ara Bihar (India) Maharaja College	SYNTHESIS, STRUCTURAL, AND ELECTRICAL ANALYSIS OF PEROVSKITE-BASED OXIDES FOR DIVERSE ELECTRONICS APPLICATIONS
Toufiki Nora Ait Omar El mehdi Bouazzama Bassou Wahid Nadya	Université Sultan Moulay Slimane Institut National de la Recherche Agronomique	TECHNICAL MANAGEMENT AND ITS IMPACT ON THE TECHNOLOGICAL PRODUCTIVITY OF BEET IRRIGATED BY MICRO-IRRIGATION INSTALLED IN A SEMI-ARID CLIMATE TADLA
Manal Hariss Ayoub Gounni Mustapha El Alami	Hassan II University	MELTING OF PHASE CHANGE MATERIAL INSIDE A RECTANGULAR ENCLOSURE WITH HEXAGONAL Y-SHAPED FINS

 DATE	• 24.01.2024	 TIME	• 12³⁰ – 14³⁰	 SESSION	• HALL-6 • SESSION-2
--	---------------------	--	--	---	---------------------------------



HEAD OF SESSION: Associate Professor Nadia FEMMAM

Asma FEMMAM Leila SRITI Nadia FEMMAM	Mohamed Khider University	MULTI-OBJECTIVE ANALYSIS OF ENERGY-EFFICIENT RESIDENTIAL BUILDINGS IN HOT, DRY CLIMATES A GENETIC ALGORITHM APPROACH
Sergiy LAVRENKO Karina MRYNSKA	Kherson State Agrarian and Economic University	THE USE OF LIVING OBJECTS IN ARCHITECTURE
Wafa Athmani Leila Sriti	Mohamed Khider University of Biskra	ADVANCING ENERGY EFFICIENCY AND THERMAL PERFORMANCE IN RESIDENTIAL BUILDINGS THROUGH COOL ROOF ENHANCEMENTS IN BISKRA, ALGERIA'S HOT AND ARID CLIMATE
Khaled Mansouri Leila Sriti	Mohamed Khider University	TOWARD SUSTAINABILITY IN BUILDINGS DESIGN.CASE OF SCHOOL BUILDING IN HOT AND DRY CLIMATES
Muhammad Aminu Musa Lawal Ahmad Tanimu	Ahmadu Bello University Kauran Namoda Polytechnic	AN EXPLORATION OF THE HISTORICAL LANDMARK AND A SYMBOL OF RESPECT FOR ZARIA TRADITIONAL INSTITUTION: KAFEN DAUDU
Sfaksi Imene Mezerdi Toufik	Mohamed Khidher University	IMPACT OF EXTERIOR VIEW ON VISUAL QUALITY AND USER SATISFACTION IN INTERIOR SPACES
Associate Professor Nadia FEMMAM Doctor Asma FEMMAM Professor Said MAZOUZ.	Mohamed Khider University of Biskra University of Oum El Bouaghi	SYNTACTIC ANALYSIS OF THE INTEGRATION OF URBAN PUBLIC SPACES OF PERIPHERAL NEIGHBORHOODS OF BISKRA CITY.

 DATE	• 24.01.2024	 TIME	• 15⁰⁰-17⁰⁰	 SESSION	• HALL-1 • SESSION-3
--	---------------------	--	--	---	---------------------------------------



HEAD OF SESSION: Assoc. Prof. Dr. Zeynep ÖZKURT

Bahri SENTURK Assoc. Prof. Dr. Arif GURSOY Assoc. Prof. Dr. İBRAHİM SENTURK	Ege University	INTERPRETATION OF SILLOGISTIC QUANTIFIERS WITH THE HELP OF GRAPH STRUCTURES
Assoc. Prof. Dr. Zeynep ÖZKURT	Çukurova University	PARTIAL DERIVATIVES OF SOME RELATIVELY FREE LEIBNIZ ALGEBRAS
Assoc. Prof. Dr. Zeynep ÖZKURT	Çukurova University	ENDOMORPHISMS OF SOME RELATIVELY FREE LEIBNIZ ALGEBRAS
Ahmet TEKİN Assoc. Prof. Dr. Arif GURSOY	Ege University	AN IMPROVED BINARY INTEGER PROGRAMMING MODEL OF THE BAND COLLOCATION PROBLEM WITH LIMITED RESOURCES
Dr. ELİF PEKSU	Istanbul Technical University	NANOSPHERE LITHOGRAPHY FOR FABRICATION OF ONE DIMENSIONAL NANOSTRUCTURES
Osman SÜNBÜL Assoc. Prof. Dr. İbrahim YÜKSEL	Gazi University	THE OPINIONS OF SCIENCE TEACHERS WHO HAVE PARTICIPATED IN SCIENCE FESTIVALS AS A STAFF MEMBER ABOUT THEIR ACADEMIC EMOTIONS AND THE PREREQUISITES OF SCIENTIFIC REASONING

		
DATE • 24.01.2024	TIME • 15⁰⁰-17⁰⁰	SESSION • HALL-2 • SESSION-3



HEAD OF SESSION: **Prof. Dr. Ahmet Selim DALKILIÇ**

Ufuk ALTUNAL Asst. Prof. Dr. Alişan GÖNÜL Assoc. Prof. Dr. Özgen AÇIKGÖZ Prof. Dr. Ahmet Selim DALKILIÇ	Yıldız Technical University Siirt University	NUMERIC AND THEORETICAL ANALYSIS OF THE HEAT TRANSFER AND PRESSURE DROP IN DOUBLE AND TRIPLE CONCENTRIC TUBE HEAT EXCHANGERS
Osman AHLATLI H. İbrahim KARAOKUR Emrah GÖNEN	Temsan Makina ve Tekstil San. Tic. A.Ş. Ar-Ge Merkezi	IMPROVEMENT OF A SYSTEM PROVIDING HOMOGENEOUS AIR SUCTION ON THE DRUM FOR A MACHINE THAT RECYCLES FIBERS FROM FABRIC AND FIBER
Ali İhsan KAYA	Adıyaman University	NATURAL FREQUENCIES INVESTIGATION OF SCARF JOINTS WITH RESPECT TO DIFFERENT SCARF ANGLES
Erdal Tunçer Murat Hüseyin Kumkale Tayfun Pektaş Dinçer AKAL	Erin Motor Arge Merkezi, İstanbul Dinex Egzoz ve Emisyon Teknolojileri San.ve Tic A.Ş.Çerkezköy, Tekirdağ Trakya Üniversitesi	THE EFFECT OF USING BIODIESEL PRODUCED FROM WASTE OILS IN A DIESEL ENGINE ON ENGINE PERFORMANCE AND EMISSIONS
Halil ATA Assoc. Prof. Dr. Sibel ZORLU PARTAL	Yıldız Technical University	DESIGN AND ACOUSTIC ANALYSIS STUDY OF PERMANENT MAGNET SYNCHRONOUS MACHINE FOR SUBMARINE APPLICATIONS
Ali İhsan MENEVŞE Asst. Prof. Dr. Eralp ŞENER Assoc. Prof. Dr. Işıl YAZAR	Eskişehir Osmangazi University Bilecik Şeyh Edebali University	ELECTRICAL SYSTEM DESIGN AND MATHEMATICAL MODELLING FOR BATTERY SUPPORTED PROPULSION SYSTEM FOR AIRCRAFT TAXIING

 DATE	• 24.01.2024	 TIME	• 15⁰⁰-17⁰⁰	 SESSION	• HALL-3 • SESSION-3
--	---------------------	--	--	---	---------------------------------------



HEAD OF SESSION: Asst. Prof. Dr. Ömer Faruk TAVŞANLI

Khalida Agadadash Kizi Talibova	Jalilabad branch of ASPU	UPBRINGING OF CHILDREN INCLUDED IN THE 'RISK GROUP'
Hasan KEMALOĞLU Assoc. Prof. Mehmet Emin USTA Dr. Ümit DOĞAN	Sakarya University Ministry of Education	OPINIONS OF TEACHERS AND ADMINISTRATORS ON THE PROBLEMS AND DIFFICULTIES ENCOUNTERED IN SCHOOLS WHERE DIFFERENT LEVELS PROVIDE EDUCATION IN THE SAME BUILDING
Res. Asst. Selin ÇİLTEPE Prof. Dr. İsmail KARAKAYA	İstanbul University-Cerrahpaşa Gazi University	ATTENTION TEST DEVELOPMENT THESIS STUDY FOR 5-7 AGE GROUP
Gülsüm GÖKTAŞ Assoc. Prof. Dr. Gülbin ZEREN NALINCI	Amasya University	EVALUATION OF SCIENTIFIC STUDIES EXAMINING THE EDUCATIONAL EFFECTS OF CREATIVE DRAMA ACTIVITIES ON TEACHER CANDIDATES
Assoc. Prof. Dr. Serap UZUNER YURT Ebru BUYURMAN Elif Nur DERViŞ Özlem TANOĞLU Rüya Ece AKTAŞ Sümeyye Burcu GÜLTEKİN	Erzincan Binali Yıldırım University	METAPHORICAL PERCEPTIONS OF 6TH GRADE STUDENTS WHO PARTICIPATED IN CREATIVE DRAMA WORKSHOPS ON WAR AND IMMIGRATION
Mehmet AKIN Prof. Dr. Şafak ULUÇINAR SAĞIR	Amasya University	DETERMINATION OF SCIENCE TEACHERS' OPINIONS ABOUT ARGUMENTATION-BASED LEARNING
Mehmet AKIN Assoc. Prof. Dr. Gülbin Zeren NALINCI	Amasya University	CLASSROOM TEACHERS'S VIEWS ON THE CREATIVITY OF PRIMARY SCHOOL STUDENTS
Asst. Prof. Dr. Ömer Faruk TAVŞANLI	İstanbul Aydın University	WAYS OF PRIMARY SCHOOL STUDENTS SHOWING THEIR EDITORIAL SKILLS ACCORDING TO THE OWNER OF THE PAPER: SOCIAL AUTHORITY IN WRITING

		
DATE • 24.01.2024	TIME • 15⁰⁰-17⁰⁰	SESSION • HALL-4 • SESSION-3



HEAD OF SESSION:

Javadov Radin Khaleddin oghlu	Qərbi Kaspi Universiteti	SOCIAL LIFE OF THE POPULATION OF IRAVAN GOVERNANCE: EDUCATION, RELIGION AND CULTURE
Javadov Radin Khaleddin oghlu	Qərbi Kaspi Universiteti	TERRITORY AND ADMINISTRATIVE SYSTEM OF IRAVAN GOVERNANCE
Səriyyə Abidova Elşən qızı	Quba şəhəri "Soyqırımı Memorial Kompleksi"	QUBA QƏZASINDA OLAN ERMƏNİ VƏHŞİLİKLƏRİ AZƏRBAYCAN QƏZETİNİN SƏHİFƏLƏRİNDƏ
Prof. Dr. M. S. Ufuk TÜRELİ Mehmet Oğuz KELEK	Yıldız Technical University	ESTIMATION OF SPECTRUM USAGE WITH MACHINE LEARNING ALGORITHMS
Res. Asst. Dr. Tarkan ÖZTÜRK	İstanbul Rumeli University	INVESTIGATION OF COMMUNICATION METHODS BETWEEN VIRTUAL ENVIRONMENTS AND USERS IN DIGITAL GAMES
Lec. Dr. Kıvanç UZUN Asst. Prof. Dr. Muhammet TORTUMLU	Uşak University Burdur Mehmet Akif Ersoy University	THE MODERATING ROLE OF GENDER IN THE IMPACT OF YOUNG ADULTS' CAREER OPTIMISM ON THEIR SELF-FORGIVENESS TENDENCIES

 DATE	• 24.01.2024	 TIME	• 15⁰⁰-17⁰⁰	 SESSION	• HALL-5 • SESSION-3
--	---------------------	--	--	---	---------------------------------------



HEAD OF SESSION: Professor Shalva Zarnadze

Kanwal Shabbir Fakhar Ud-Din Sidra Bashir	Quaid-i-Azam University	NITAZOXANIDE AND QUERCETIN CO-LOADED NANOTRANSFERSOMAL GEL FOR TOPICAL TREATMENT OF CUTANEOUS LEISHMANIASIS WITH MACROPHAGE TARGETING AND ENHANCED ANTI-LEISHMANIAL EFFECT
Temur Kopadze	Tbilisi State Medical University Student Scientific-Research Club "ENDEAVOR" of Scientific Research-Skills Center of TSMU	MULTISYSTEM EFFECTS OF GOUT ON THE BODY
Professor Shalva Zarnadze Professor Irine Zarnadze	TSMU	HEALTH AND OCCUPATIONAL BEHAVIOR OF THE YOUNG POPULATION, GLOBAL CHALLENGES OF THE MODERN WORLD
Dr. Namrata Kumari	Gauhati University	ECOLOGY OF JAPANESE ENCEPHALITIS DISEASE
OUADAH Angham BENBIA Souheyla SOUALHI Sabah CHAFAI Aya MOUAKI BENNANI Safa BELKHIRI Yamina FERROUDJI Nor El Amel	University of Batna	THE ENVIRONMENTAL IMPACT OF OPIOIDS ON FEMALE SEX HORMONES: META-ANALYSIS STUDY
Nor El Amel FERROUDJI Yamina BELKHIRI Souheyla BENBIA Angham OUADAH Safa MOUAKI BENNANI Aya CHAFAI	University of Batna	THE EFFECT OF ANTIBIOTICS ON MALE REPRODUCTIVE HORMONES: A META- ANALYSIS
Priyanshi Goyal Akash Upadhyay	Mangalayatan University	RECENT ADVANCEMENT ON MICROFLUIDIC TECHNOLOGIES FOR CANCER
Chafai Aya Yahia Massinissa Benbia Souheyla Soualhi Sabah Ouadah Angham Mouaki Bennani Safa Ferroudji Nor El Amel Belkhiri Yamina	University of Batna	THE IMPACT OF CODEIN ON THE HUMAN ENDOCRINE SYSTEM AND MALE FERTILITY: A META-ANALYSIS

		
DATE • 24.01.2024	TIME • 15⁰⁰-17⁰⁰	SESSION • HALL-6 • SESSION-3



HEAD OF SESSION: Dr. Karima FEMMAM

Dr. Karima FEMMAM	University of Mohamed Khider	A FEATURE EXTRACTION TECHNIQUES BASED ON BIVARIATE COPULAS
Madhukrishna Chakraborty	Jadavpur University	NON-LINEAR RAYCHAUDHURI EQUATION AND THE DYNAMICS OF COSMIC EVOLUTION
Ayinde Muhammed Abdullahi Azeez Qowiy Akinremi Ishaq Ajimoti Adam Ibrahim Salihu	University of Abuja Al-Hikmah University	COLLOCATION APPROXIMATION TECHNIQUES FOR SOLVING INTEGRO-DIFFERENTIAL EQUATIONS VIA SHIFTED CHEBYSHEV POLYNOMIAL
Ayinde Muhammed Abdullahi Arowolo Victor Joel Ishaq Ajimoti Adam Ajileye Ganiyu	University of Abuja Al-Hikmah University Federal University of Wukari	COMPUTATIONAL ALGORITHMS FOR SOLVING LINEAR ORDINARY DIFFERENTIAL AND INTEGRAL EQUATIONS USING SHIFTED LEGENDRE POLYNOMIALS
Prof Ugorji I. Ogbonnaya Mrs. Mary-Jane Dreyer	University of Pretoria	REPRESENTATIONAL FORMS AND CONTEXTUAL FEATURES OF PROBABILITY QUESTIONS IN SOUTH AFRICAN GRADES 10 AND 11 MATHEMATICS TEXTBOOKS
Subuhi Khan Mehnaz Haneef Mumtaz Riyasat	ALIGARH MUSLIM UNIVERSITY	ALGEBRAIC THEORY OF DEGENERATE GENERAL BIVARIATE APPELL POLYNOMIALS AND RELATED INTERPOLATION HINTS
Moin Uddin	Aligarh Muslim University	GAUSS-NEWTON METHOD FOR CONVEX COMPOSITE OPTIMIZATION PROBLEMS ON RIEMANNIAN MANIFOLDS
Anupam Khanna	DAV College	CHALLENGES IN PUBLISHING RESEARCH PAPERS IN JOURNALS

 DATE	• 25.01.2024	 TIME	• 09⁰⁰-11⁰⁰	 SESSION	• HALL-1 • SESSION-1
--	---------------------	--	--	---	---------------------------------------



HEAD OF SESSION: Asst. Prof. Dr. Şahin SÖZEN

Fevzi İlker KARAKUŞ Asst. Prof. Dr. Seda HATİPOĞLU Assoc. Prof. Dr. Mustafa Kürşat ÇUBUK	Gazi University	MODELING OF SIGNALIZED INTERSECTIONS ON ATATÜRK AVENUE IN ANTALYA PROVINCE WITH MICROSIMULATION TECHNIQUE
Ali ALTAŞ Ismail DABANLI	Istanbul Technical University	PROBABILISTIC DROUGHT EVALUATION IN TÜRKİYE
Sevde KURT Assoc. Prof. Dr. Aydın KAVAK	Kocaeli University	ANALYSIS OF BUILDING PILE SOIL INTERACTION WITH PLAXIS 3D PROGRAM
Asst. Prof. Dr. Şahin SÖZEN	Tokat Gaziosmanpaşa University	EVALUATION OF THE SEISMIC PERFORMANCE OF A MASONRY STRUCTURE: AMASYA ÇİLEHANE MOSQUE AND ITS COMPLEX
Zeynep POLAT Asst. Prof. Dr. Önder EKİNCİ	Kocaeli University	EVALUATION OF URBAN STORMWATER DRAINAGE SYSTEMS IN THE CASE OF YALOVA
Res. Asst. Dr. Sekavet ASLANOV Res. Asst. Dr. İsa ELBİSTAN Res. Asst. Dr. Zeynep KOCAASLAN Assoc. Prof. Dr. Bora BARUT	Inonu University	NUCK KANAL KİSTİ BİR VAKA SUNUMU

		
DATE	TIME	SESSION
• 25.01.2024	• 09⁰⁰–11⁰⁰	• HALL-2 • SESSION-1



HEAD OF SESSION: Prof. Dr. Tahir Balcı

Cavadzadə Gülşən	Lenkeran State University	İNGİLİS DİLİ DƏRSLƏRİNDƏ TƏDRİS TEKNOLOGİYASI VƏ MÜASİR METODLAR
Günəl HACIYEVA	Azerbaijan University of Languages	MASTERING ENGLISH IDIOMS IN TERMS OF PRACTICAL COMMUNICATION AND THE FORMATION OF SKILLS FOR THEIR EFFECTIVE USE
Pervin TÜZER	Çukurova University	HOW TO TRANSFORM EDUCATION IN EFL CONTEXT: THE IMPORTANCE OF ACTION RESEARCH
Prof. Dr. Tahir Balcı Prof. Dr. Munise Aksöz	Çukurova University	FEATURES OF GERMAN AND TURKISH IN TERMS OF SEPARATING SYLLABLES
Prof. Dr. Tahir Balcı Prof. Dr. Munise Aksöz	Çukurova University	CULINARY LINGUISTICS
Res. Asst. Dr. Sürreya KAVAL	Dicle University	ANALYSIS OF THE FAIRY TALE NAMED HEZALOK AND DELALOK FROM SYRT ARAB FOLK TALES WITH VLADIMIR PROPP'S FAIRY TALE ANALYSIS METHOD
Bazarbayeva Gulfairuz	Kyzylorda University named after Korkyt Ata	THE IMPORTANCE OF DEVELOPING CRITICAL THINKING IN THE EDUCATIONAL PROCESS
Zeinollakizi Mereke	Al-Farabi Kazakh National University	PHENOMENOLOGY OF READING AS A TYPE OF EDUCATION

 DATE	• 25.01.2024	 TIME	• 09⁰⁰-11⁰⁰	 SESSION	• HALL-3 • SESSION-1
--	---------------------	--	--	---	---------------------------------



HEAD OF SESSION: **Assoc. Prof. Dr. Sedat Belbağ**

Bahattin Emre ÖZDEMİR Asst. Prof. Dr. Esra İLBAHAR	Yıldız Technical University	SEGMENTATION PRACTICES IN THE BANKING SECTOR
Emre ŞENAY Assoc. Prof. Dr. Özgür AKPINAR	Marmara University	NATURAL DISASTER INSURANCE, TURKEY AND JAPAN COMPARISON
Ayçenur KİLERCİ Elif GÜNEREN GENÇ	İstanbul Ticaret University	AN EMPRICAL STUDY ABOUT AWARENESS OF NFTS'
Assoc. Prof. Dr. Aybegüm Güngördü Belbağ Assoc. Prof. Dr. Sedat Belbağ	Bartın University Ankara Hacı Bayram Veli University	INTENTION TO USE MOBILE PAYMENTS DURING THE PANDEMIC: A SYSTEMATIC LITERATURE REVIEW
Ayşe UTKAN KAHRAMAN Asst. Prof. Dr. Tuğba DAYIOĞLU	Nişantaşı University	THE EFFECTS OF THE PANDEMIC ON CONSUMER BEHAVIOR IN THE FIELD OF E-COMMERCE: THE CASE OF İSTANBUL
Professor P.Ə.Həsənova T.Z.Daşdəmirova	BDU-nun "İqtisadiyyat" kafedrası	AZƏRBAYCAN MÜASİR İQTİSADİ İNKİŞAF YOLUNDA
Prof. Dr. Süreyya KARSU	Bolu Abant İzzet Baysal University	INNOVATIVE ENERGY, HYDROGEN and TÜRKİYE's ASPECT

 DATE	• 25.01.2024	 TIME	• 09⁰⁰–11⁰⁰	 SESSION	• HALL-4 • SESSION-1
--	---------------------	--	--	---	---------------------------------------



HEAD OF SESSION:

JACOB, Ojonugwa Professor Adeyeye M.M Associate Professor Ijiaya M. A Abraham M. I (Ph.D) JAMES, Ayuba Idakwo	Federal University of Technology Prince Abubakar Audu University KOGI STATE POLYTECHNICS	OBSERVATION METHOD AND GROWTH OF WOODWORK MANUFACTURING FIRMS IN NORTH-CENTRAL, NIGERIA
Ahmad Firdhaus Arham Ahmad Shazrin Mohamed Azmi Sathees Balachandru Muhammad Firdaus Aziz Jamsari Alias	Universiti Teknologi MARA (UiTM) Pusat Pengajian Citra Universiti (CITRA-UKM)	'DON'T PUT ALL YOUR EGGS IN ONE BASKET': A COMPREHENSIVE STRATEGY FOR RESILIENT REAL ESTATE INVESTMENT DIVERSIFICATION PORTFOLIO
DR. DEEPALI TOMAR	Himalayiya University	ROLE OF WOMEN ENTREPRENEURS – A COMPARATIVE STUDY OF RAJASTHAN AND UTTARAKHAND
Terentiy ZHUIKOV Olexandr ZHUIKOV	Kherson State Agrarian and Economic University	ECONOMIC-BIOENERGETIC AND ECOLOGICAL ASPECTS OF BIOLOGIZATION OF SUNFLOWER GROWING TECHNOLOGY IN THE CONDITIONS OF THE SOUTHERN STEPPE
Nataliia LAVRENKO Vadim LOBODA	Kherson State Agrarian and Economic University	FEATURES OF LAND RESOURCES AND LAND USE MANAGEMENT
Abdul-karim, I. F. Subair, S. K. Yusuf, O. J. Adefalu, L. L.	Cocoa Research Institute of Nigeria Kwara State University University of Ilorin	CONSTRAINTS TO ADOPTION OF EXPORT STANDARD PRACTICES (ESP) AMONG COFFEE- BASED FARMERS IN KOGI STATE, NIGERIA
Ass. Prof. Dr. Thëllëza Latifi Sadrija Prof. Ass. Dr. Behrije Ramaj Desku	University "Haxhi Zeka"	THE IMPORTANCE OF BUSINESS COMMUNICATION IN THE DIGITAL AGE
Hajar BHAR Bouchra AIBOUD BENCHEKROUN	Sidi Mohamed Ben Abdellah University	DESIGN THINKING FOR EFFECTIVE FRAUD PREVENTION

 DATE	• 25.01.2024	 TIME	• 09⁰⁰-11⁰⁰	 SESSION	• HALL-5 • SESSION-1
--	---------------------	--	--	---	---------------------------------



HEAD OF SESSION: Major Gheorghe GIURGIU

Tsegmid Namsrajav	Mongolian university of life sciences	WINTER BIRDS IN THE TRANS-ALTAI GOBI DESERT
Deborah Dara Oladeji	Federal College of Agriculture	INFLUENCE OF TURMERIC RHIZOME (CURCUMA LONGA LINN) POWDER ON THE HISTOPATHOLOGY OF BROILER CHICKENS AT FINISHING PHASE
Major Gheorghe GIURGIU Prof dr med Manole COJOCARU	Deniplant-Aide Sante Medical Center Titu Maiorescu University	CLINICAL AND ANIMAL STUDIES HAVE SHOWN THAT GUT MICROBIOME DISTURBANCES CAN AFFECT NEUROMUSCULAR FUNCTION
Raji Lukman Olademeji Uko Iranyang Bazon Omoniyi Bilikis Olawumi Olatunde, Akintunde Olatunji Adeyemi, Ayobola Bamidele Nwaigwe, Chukwuemeka Onyekachi Nwaigwe, Chioma Uchenna	University of Ilorin Federal University University of Nigeria	EFFECT OF PESTE DES PETITS RUMINANTS (PPR) VACCINATION ON THE SEMEN CHARACTERISTICS OF WEST AFRICAN GOAT DWARF BUCKS
Mujahid Ali Muhammad Mohsan Asif Iqbal Malik Muhammad Akram Tahir Mehmood	Water Management Research Farm RenalaKhurd Water Management Wing	EVALUATION OF WATER PRODUCTIVITY OF RESPONSIVE DRIP IRRIGATION AND FURROW IRRIGATION IN BITTER GOURD
Ilnura Ibragimovna Fayzullina Ilya Nikolayevich Medvedev	Russian Biotechnological University	PHYSIOLOGICAL FEATURES OF BLOOD PARAMETERS OF FIRST-CALF COWS AND RECALVING COWS OF BLACK-AND-BROWN BREED THREE WEEKS BEFORE CALVING
Assistant professor Hadjira FEMMAM Dr. Karima FEMMAM Dr. Hayet MEKAOUSSI	University of Hadj Lakhdar Batna1 University of Mohamed Khider	PREDICTIVE MODELING OF TIME SERIES FOR SPECIFIC EROSION USING RECURRENT NEURAL NETWORKS: A CASE STUDY OF THE WATERSHED OF THE KOUDIET LEMDAOIR DAM, BATNA, ALGERIA

 DATE	• 25.01.2024	 TIME	• 11³⁰-13³⁰	 SESSION	• HALL-1 • SESSION-2
--	---------------------	--	--	---	---------------------------------------



HEAD OF SESSION: Prof. Dr. Ahmet AKIN

Prof. Dr. Ahmet AKIN Selin Cennet TÜRKER	İstanbul Medeniyet University	LOYALTY SCALE IN ROMANTIC RELATIONSHIPS: VALIDITY AND RELIABILITY STUDY
Tayfur Can Assoc. Prof. Dr. Nevin Günaydın	Ordu University	RUH SAĞLIĞI OKURYAZARLIĞI
Tayfur Can Assoc. Prof. Dr. Nevin Günaydın	Ordu University	YAYGIN ANKSİYETE BOZUKLUĞU
Gamze KARS Assoc. Prof. Dr. Nevin GÜNAYDIN	Ordu University	RISK FACTORS ASSOCIATED WITH POSTPARTUM DEPRESSION
Prof. Dr. Ahmet AKIN Zehra SAÇMALI	İstanbul Medeniyet University	TRUST IN THE FAMILY SCALE: VALIDITY AND RELIABILITY STUDY
Prof. Dr. Ahmet AKIN Orçun Dirik	İstanbul Medeniyet University	DOMESTIC MOBBING SCALE: VALIDITY AND RELIABILITY STUDY
Prof. Dr. Ahmet AKIN Çağlar YÜCE	İstanbul Medeniyet University	QUALITY TIME IN THE FAMILY SCALE: VALIDITY AND RELIABILITY STUDY
Gamze KARS Assoc. Prof. Dr. Nevin GÜNAYDIN	Ordu University	PERCEIVED STRESS IN NURSES AND METHODS OF COPING WITH STRESS

		
DATE	TIME	SESSION
• 25.01.2024	• 11³⁰–13³⁰	• HALL-2 • SESSION-2



HEAD OF SESSION: **Asst. Prof. Dr. Recep BİLGİN**

Melike MIKIR	Ankara Yıldırım Beyazıt University	THE CONCEPT OF MIRACLE AND ITS SYNONYMS/NEAR SYNONYMS EXPLAINED BY TĀHİR İBN 'ĀSHŪR IN HIS WORK AL-TAHRİR WA'L-TANWİR
Asst. Prof. Dr. Recep BİLGİN	Hatay Mustafa Kemal University	DEFINITION, VALUE AND PLACE OF TALFĪK AL-ISNĀD IN HADĪTH METHODOLOGY
Mustafa Fahri KUVAN	İstanbul Aydın University	PROCESSING OF PERSONAL DATA ABOUT THE EMPLOYEE BY THE EMPLOYER, VIOLATIONS AND SANCTIONS
Said Yaşar DEMİRÖZ	İstanbul Aydın University	THE IMPACT OF ARTIFICIAL INTELLIGENCE TECHNOLOGIES ON COMBATING THE INFORMAL ECONOMY IN TURKISH LAW
Assoc. Prof. Dr. Aytaç AYDIN Zeynep USTAĞLU	Ankara Yıldırım Beyazıt University	THE ATTITUDE OF TODAY'S COLLECTIVE İJTIHAD INSTITUTIONS AGAINST GENETIC DEVELOPMENTS: THE ISLAMIC FİQH COUNCIL AND INTERNATIONAL ISLAMIC FİQH ACADEMY
Assist Prof. Dr. Buse KESKİNDAG Assoc Prof. Dr. Hüseyin GÜNEY Assoc. Prof. Dr. Meryem KARAAZİZ	Bahçeşehir Cyprus University Near East University	CHATBOT-DELIVERED BRIEF INTERVENTION FOR NEGATIVE SELF-THOUGHTS: PROTOCOL FOR RANDOMISED CONTROLLED TRIAL
Sabina GARASHOVA	Baku State University	ARMENIANISM IN MODERN ARMENIA: FROM THE PERSPECTIVE OF INTERNATIONAL RELATIONS
Asst. Prof. Dr. Serap ERÇİN KOÇER	Uşak University	OLD MOSQUE OF DÜZKİŞLA VILLAGE IN BANAZ DISTRICT OF UŞAK PROVINCE

 DATE	• 25.01.2024	 TIME	• 11³⁰–13³⁰	 SESSION	• HALL-3 • SESSION-2
--	---------------------	--	--	---	---------------------------------



HEAD OF SESSION: Assoc. Prof. Dr. Noorjahan Banu Mohamed Alitheen

Hafsa Ilyas Usman Haider Humaria Muzaffar Wania Nasir Najeeb Ullah Khan Mahoor Jamil Bilal Aslam Jawad Aslam Shamshad Ul Hassan Wafa Majeed Muhammad Naeem Faisal	University of Agriculture Faisalabad	ANALYZING THE ANTI-REGENERATIVE ACTIVITY OF FAGONIA INDICA EXTRACT AGAINST ARSENIC-INDUCED LIVER INJURY MODEL
Assoc. Prof. Dr. Noorjahan Banu Mohamed Alitheen Dr. Noorshafadzilah Talib	Universiti Putra Malaysia	ANTI-DIABETIC EFFECTS OF ISOLATED LACTOBACILLUS PARACASEI FROM MALAYSIAN WATER KEFIR GRAINS SAMPLE IN TYPE 2 DIABETES-INDUCED C57BL/6 MICE
Neha Kambo Rahul Kumar Dr. Navin Kumar Prof. Dr. Pankaj Gautam	Graphic Era (Deemed to be University)	PLANT AND ANIMAL BASED ANTIMICROBIAL PEPTIDES
Vaanie Godbole Pankaj Gautam Manoj Kumar Pal	Graphic Era (deemed to be) University	POTENTIAL OF MICROALGAE IN MICROBIAL FUEL CELLS (MFCs): A REVIEW
Saleh Abed ALWahed Mahdi Kamil M AL-Jobori Wafaa S. M. Mohsen	University of Baghdad University of Karbala	EPIDEMIOLOGICAL AND PHYLOGENETIC STUDY OF ESCHERICHIA COLI AND STAPHYLOCOCCUS AUREUS ISOLATED FROM DAIRY COWS, WORKERS AND SHARED FARM ENVIRONMENTS IN KARBALA GOVERNORATE- IRAQ
MOUAKI BENNANI Safa BENBIA Souheyla CHENKHOULFI hadba GASMI manel OUADAH Angham CHAFAI Aya FERROUDJI nor el amel BELKHIRI Yamina	University of Batna	NONSTEROIDAL ANTI-INFLAMMATORY DRUGS ACT AS ENDOCRINE DISRUPTORS IN FEMALES REPRODUCTION: A SYSTEMATIC REVIEW AND A META-ANALYSIS OF PLACEBO INTERVENTIONS STUDIES
Nike, Tawakaltu Isyaku Suleiman Jafaru Ukatu, Victoria E. Bagudo, A. I.	Kebbi State University of Science and Technology Sokoto State University	CLINICAL MANIFESTATIONS ASSOCIATED WITH SCHISTOSOMA HAEMATOBIIUM INFECTION AMONG PEOPLE IN RIVERINE COMMUNITIES OF SOKOTO STATE NIGERIA

 DATE	• 25.01.2024	 TIME	• 11³⁰–13³⁰	 SESSION	• HALL-4 • SESSION-2
--	---------------------	--	--	---	---------------------------------



HEAD OF SESSION: Dr. Radouane EN-NADIR

Glenys Lajurus David Jasmine P. Molidu	Keningau Vocational College	PORTABLE CHAIRS FOR BEAUTICIANS
ANBARASAN A BALAJI A GANGAARAAM MR	R.M.K. ENGINEERING COLLEGE	SMART FOOTSTEP POWER GENERATION
Dr. Radouane EN-NADIR	Sidi Mohamed Ben Abdellah University	PERFORMANCE OF InGaN-BASED INTERMEDIATE BAND SOLAR CELL AS NEXT- GENERATION PHOTOVOLTAIC TECHNOLOGY
Mugesh S Avinash B Mohamed Sulaiman Saravanan S	Annamalai University	FABRICATION OF AUTOMATIC LEAF PLATE MAKING MACHINE
Narin Fatehi Saeed Olyae	Shahid Rajae Teacher Training University	A NOVEL PROPOSAL FOR PHOTONIC CRYSTAL- BASED PEROVSKITE SOLAR CELL
Nishant Kumar Singh Bholey Singh	Harcourt Butler Technical University GL Bajaj Group of Institutions	ADDITIVE MANUFACTURING: NEW RESEARCH VISTAS WITH MULTIDIMENSIONAL ASPECTS
Kamarul Hawari Ghazali	Universiti Malaysia Pahang Al- Sultan Abdullah	LANDSLIDE EARLY WARNING SYSTEM UTILIZING GNSS TECHNOLOGY
Saja Murtadha Hashim Kürşat Mustafa KARAOĞLAN	Karabuk University	ADVANCES IN NAME ENTITY RECOGNITION: EXPLORING STATE-OF-THE-ART METHODS

		
DATE • 25.01.2024	TIME • 11³⁰-13³⁰	SESSION • HALL-5 • SESSION-2



HEAD OF SESSION:

Prof. Dr. Ariffin Abdul Mutalib Nursauri Yahaya	Universiti Utara Malaysia	EDUCATING COMMUNITY THROUGH IMMERSIVE VIRTUAL REALITY
Ms Kai Ge Bai Assoc Prof Dr Kim Hua Tan Dr Mohd Nor, N. H	Taylor's University	EXPLORING CHATGPT TECHNOLOGY AND METAVERSE IN FUTURE INTERPERSONAL COMMUNICATION SCENARIOS: BASED ON THE S-O-R MODEL
Ajayi, Olayemi T. Akinyemi, Dolamu S.	Lead City University The Federal Polytechnic	GRAPHIC ELEMENTS IN TEXTILE BRANDING: AESTHETIC IDENTITY AND MARKET PERCEPTION
Mashitoh Yaacob Nur Izzah Fakhruaazi Nur Irdina Amni Mohd Sholehen Siti Nur Alisa Rushdan Sofi Masturah Mohammad Nurul Zainina Zam Halim Nor Mahfuzah Mohama	Pusat Pengajian Citra Universiti Universiti Kebangsaan Malaysia (UKM)	RESIDENTS' PERSPECTIVES OF TOURIST ATTRACTION FACTORS, THE IMPACTS AND IMPROVEMENTS TOWARDS HULU LANGAT HOT SPRINGS, SELANGOR, MALAYSIA
Raffi Muhammad Dewantara Devani Laksmi Indyastuti Ade Irma Anggraeni	Universitas Jenderal Soedirman	UNDERSTANDING INFORMATION TECHNOLOGY IN TOURISM INDUSTRY
BOLAJI Kofoworola Adedigba AHMED Ahmed Olaitan ADEBAYO Dorcas Oluwakemi KABIR Ganiyat Bello OKE D. O	Forestry Research Institute of Nigeria	HARNESSING TECHNOLOGY FOR EFFICIENT SUSTAINABLE FOREST MANAGEMENT IN THE 21ST EPOCH
Mohammad Zafar Wassan Prof.Dr.Faiz Muhammad Shaikh	Conservator Forest-Larkana SZABAC-Dokri-Sindh-Pakistan	IMPACT OF AGROFORESTRY ON LIVELIHOODS OF RURAL PEOPLE IN SINDH: A CASE STUDY OF HYDERABAD SINDH-PAKISTAN
Mohammad Zafar Wassan Prof.Dr.Faiz Muhammad Shaikh	Conservator Forest-Larkana SZABAC-Dokri-Sindh-Pakistan	IMPACT OF AGROFORESTRY FERTILITY IMPROVEMENT: A CASE STUDY OF HYDERABAD SINDH-PAKISTAN

 DATE	• 25.01.2024	 TIME	• 14⁰⁰–16⁰⁰	 SESSION	• HALL-1 • SESSION-3
--	---------------------	--	--	---	---------------------------------------



HEAD OF SESSION: **Dr. Subhashish Dey**

Dr.Eng.Aishah H.O. Al Shehhi Dr.Gul Ahmed Jokhio	Ministry of Energy and Infrastructure The British University in Dubai	RECYCLE ASPHALT OPPORTUNITIES IN ROADWAYS
Wajahat Ali Shakeel Javaid Mohammad Nabeel Sayed Hamid Hashemi Petrudi	Aligarh Muslim University	OPTIMIZING PARKING LOT DESIGN: A COMPREHENSIVE STUDY ON SPACE UTILIZATION AND TRAFFIC FLOW
Ankur Singh Ayushi Kimothi Edan Khan	Sharda University Graphic Era (Deemed to be University)	A COMPREHENSIVE EXPLORATION OF THE IMPLEMENTATION OF BIOMATERIALS IN AUTOMOTIVE MANUFACTURING
Mohd Khairul Nizam ISMAIL Herman Shah ANUAR Faisal ZULHUMADI	Mazda Group of Company, Kulim High Tech Park University Utara Malaysia	STRATEGIC PROCUREMENT IN MALAYSIA AUTOMOTIVE INDUSTRY: KEY CRITERIA FOR SUPPLIER SELECTION PROCESS BY TIER ONE SUPPLIER
U. Elaiyaran G.V. Hariharan C. Jayabalan C. Rajaravi J. Paulmar Pushparaj	Easwari Engineering College Sri Sairam Institute of Technology AMET University Hindustan College of Engineering & Technology	EVALUATION OF MECHANICAL AND MICROSTRUCTURE PROPERTIES OF SINTERED WC/CU POWDER COMPOSITE DEVELOPED USING POWDER METALLURGY
Sholadoye, Idayat. O, Bitrus Emmanuel. A Abdulrahaman Jibril Umar	Federal Polytechnic Kaura Namoda	COMPARATIVE STRENGTH OF THE SAW DUST ASH REPLACEMENT WITH CEMENT IN CONCRETE MIX
Subhashish Dey	Gudlavalleru Engineering College	APPLICATIONS OF SOLID WASTE MANAGEMENT IN ROAD CONSTRUCTIONS OF INDIA
Wan Nadzri Osman Mohd Nasrun Mohd Nawi Faisal Zulhumadi Kamaruddin Radzuan	Universiti Utara Malaysia	CONSTRUCTION PROJECT SUCCESS: INVESTIGATING CRITICAL SUCCESS FACTORS (CSFs) FOR EFFECTIVE PROJECT MANAGEMENT IN THE CONSTRUCTION INDUSTRY



 DATE	• 25.01.2024	 TIME	• 14⁰⁰–16⁰⁰	 SESSION	• HALL-2 • SESSION-3
--	---------------------	--	--	---	---------------------------------

HEAD OF SESSION: Assistant Professor K.R.Padma

Nato Alavidze Nodar Sulashvili	Akaki Tsereteli State University East European University The University of Georgia	THE MANIFESTATION OF FEATURES OF PROBLEM-BASED LEARNING IN PHARMACOLOGY, A SURVEY OF DEPARTMENT HEADS IN GEORGIAN MEDICAL UNIVERSITIES
Nodar Sulashvili Nato Alavidze Ekaterine Lomia	The University of Georgia Akaki Tsereteli State University East European University Mongolian International University	THE SCIENTIFIC TALKS OF THE FEATURES OF IMPACT OF DIGITAL HEALTH FROM PHARMACY PRACTICE AND HEALTH CARE POLICY PERSPECTIVES
Tamar Okropiridze Nodar Sulashvili	The University of Georgia	THE MANIFESTATION OF CHARACTERISTICS PERIODONTAL DISEASES IN CHILDREN VS THE BACKGROUND OF SOMATIC DISEASES
Nodar Sulashvili Nato Alavidze Ekaterine Lomia	The University of Georgia Akaki Tsereteli State University East European University Mongolian International University	THE MANIFESTATION OF THE SCIENTIFIC DISCUSSION OF PHARMACEUTICAL EDUCATION OPPORTUNITIES AND SPECIFIC PROFESSIONAL FEATURES OF THE JUNIOR PHARMACISTS IN GEORGIA
Assistant Professor K.R.Padma K.R.Don	Sri Padmavati Mahila Visvavidyalayam (Women's) University Bharath University	A REVIEW ON THE CHEMICAL COMPOSITION AND PHARMACOLOGICAL ACTIVITIES OF GARLIC
Dr.Foziyah Zakir Dr. Amrita Mishra Rahmuddin khan	Delhi Pharmaceutical Sciences and Research University School of Pharmaceutical Education & Research	AYURVEDA: AN ANCIENT STRATEGY FOR ONE HEALTH
Yadvendra Singh Thenuan	Mangalayatan University	A CRITICAL REVIEW ON NOVEL DRUG DELIVERY SYSTEM
Ragini Kahera	Graphic Era (deemed to be) University	ENCAPSULATION METHODS FOR ANACARDIUM OCCIDENTALE ESSENTIAL OIL AND ITS MARKET DEMAND: IMPROVING ANTIMICROBIAL DELIVERY



 DATE	• 25.01.2024	 TIME	• 14⁰⁰–16⁰⁰	 SESSION	• HALL-3 • SESSION-3
--	---------------------	--	--	---	---------------------------------------

HEAD OF SESSION:		
Syeda Sabika Zahra Naqvi Syed Mohsan Raza Shah Zaheer Abbas Muhammad Javed	University of Education	LEAF STRUCTURAL AND FUNCTIONAL MODIFICATION OF IPOMOEA CARNEA JACQ. AN INVASIVE PLANT SPECIES, UNDER DIVERSE SALINITY GRADIENT
Syeda Sabika Zahra Naqvi Syed Mohsan Raza Shah	University of Education	MORPHO-ANATOMICAL MODIFICATION IN WITHANIA SOMNIFERA (L.) DUNAL FROM PUNJAB, PAKISTAN: INSIGHT INTO ADAPTATION
Syeda Sabika Zahra Naqvi Syed Mohsan Raza Shah Zaheer Abbas Muhammad Javed	University of Education	STRUCTURAL AND FUNCTIONAL MODIFICATION IN CYMBOPOGON JWARANCUSA (JONES) SCHULT. INHABITING HOT HYPERSALINE DESERT
Saiqa Andleeb Kanwal Tahir Kaleem Imdad	University of Azad Jammu and Kashmir COMSATS University	INHIBITION OF WATER-BORNE BACTERIAL PATHOGENS BY BACTERIA ASSOCIATED WITH SPIROGYRA
Dr. Gopi Reddy Raveendra Reddy Dr. Muram Subba Reddy Dr. Suguru Subba Rayudu Dr.K.Venkata Subba Reddy	SBVR Degree and PG College	ETHYL IMIDAZOLE-1-CARBOXYLATE AS A NOVEL CARBOXYLATING AGENT FOR THE SYNTHESIS OF 1,2,4-OXADIAZOL-5(4H)-ONES AND EVALUATION OF THEIR ANTI- MYCOBACTERIAL ACTIVITY
Yusuf Hassan Muhammad Zakariyya Yusuf	Umaru Musa Yar'adua University	EFFECT OF SOLVENT ON THE PREPARATION OF AROMATIC ACYLALS CATALYSED BY SILICA- HYDROCHLORIC ACID MIXTURE

 DATE	• 25.01.2024	 TIME	• 14⁰⁰–16⁰⁰	 SESSION	• HALL-4 • SESSION-3
--	---------------------	--	--	---	---------------------------------------



HEAD OF SESSION:

Associate Professor Victoria POSTOLACHE	Alecu Russo Balti State University	ANALYSIS OF CONCEPTUAL APPROACHES AND IDENTIFICATION OF KEY STAGES OF ENTERPRISE RISK MANAGEMENT
PhD Student, Afruza Akter Associate Professor Dr Kim Hua Tan	Taylor's University	INVESTIGATING THE MOTIVATIONAL FACTORS OF USING AGRO-BASED MOBILE APPS AMONG FARMERS; STUDY FROM CHANDPURA VILLAGE OF BARISAL, BANGLADESH
Ikenna Charles Ukwuaba Chukwuemeka John Arene Chiedozie Benjamin Okpukpara	University of Nigeria	SMALLHOLDER COMMERCIALIZATION: WHAT DRIVES THE HOUSEHOLD WELFARE OF SMALLHOLDER RICE FARMERS IN SOUTHEAST NIGERIA?
Okeibunor Augustine Obasi Onyinyechi Hope Mayah Eunice	Federal College of Education (Technical)	QUALITY ASSURANCE IN THE MANAGEMENT OF BUSINESS EDUCATION PROGRAMME IN NIGERIAN COLLEGES OF EDUCATION
Prof. Asoc. Dr. Ismail Mehmeti Prof. As. Dr. Gazmend Deda Prof. Asoc. Dr. Arben Tërstena Prof. Asoc. Dr. Sokol Krasniqi	University of Applied Sciences in Ferizaj	LEGISLATION AS A SUPPORTING DETERMINANT OF BUSINESS DEVELOPMENT - THE CASE OF KOSOVO
Assistant Professor, Sayanti Das Assistant Professor, Dr. Monalisa Halder Dr. Jinia Datta Dibakar Das	Abacus Institute of Engineering and Management	ADVERSE EFFECT OF CLIMATE CHANGE ON INDIAN ECONOMY
Subhom Ghosh Akash Santra Atanu Koley Dr. Monalisa Halder	Abacus Institute of Engineering and Management,	GENETIC APPLICATION IN AGRICULTURE
Shayan Ghosh Souvik Paul Soumojit Barui Dr. Monalisa Halder	Abacus Institute of Engineering and Management	ARTIFICIAL INTELLIGENCE IN HAEMATOLOGY

 DATE	• 25.01.2024	 TIME	• 14⁰⁰–16⁰⁰	 SESSION	• HALL-5 • SESSION-3
--	---------------------	--	--	---	---------------------------------------

HEAD OF SESSION: Dr. María Victoria ARENAS VELA

Natalia Bolgari Ina Andoni	Academy of Economic Studies of Moldova	ENHANCING BUSINESS ENGLISH TEACHING THROUGH MULTIMODALITY: A PRACTICAL APPROACH
Svitlana Myshko Katalyn Lizák Anatolii Myshko	Uzhhorod National University Professor, Ferenc Rákóczi II Tanscarpathian Hungarian College of Higher Education	CERTAIN ISSUES IN FOREIGN LANGUAGES ACQUISITION
Anatolii Myshko Florian Yatsko	Uzhhorod National University	DYNAMICS AND PACE OF IMPLEMENTATION OF THE ASSOCIATION AGREEMENT BETWEEN UKRAINE AND THE EUROPEAN UNION IN THE CONTEXT OF EUROPEAN INTEGRATION
Shuaeeb, A. I., Mufidat, A. A., Kabir, I. M., Yaki, A. A. Babagana, M.	Federal University of Technology Minna	ASSESSMENT OF AWARENESS AND KNOWLEDGE OF ECO-LITERACY CONCEPTS AMONG PRE-SERVICE SCIENCE TEACHERS OF FEDERAL UNIVERSITY OF TECHNOLOGY, MINNA
Ilya Nikolaevich Medvedev	Kursk State University	FUNCTIONAL PERFORMANCE OF FRESHMEN STUDENTS WHO ARE ENTHUSIASTIC ABOUT BASKETBALL TRAINING
Romanova Anastasia	The Academy of Economic Studies of Moldova	LISTENING COMPREHENSION STRATEGIES AND THEIR APPLICATION
María Victoria ARENAS VELA	National University of Distance Education (UNED)	THE IMPORTANCE OF SPEAKING IN PUBLIC AND HOW TO TEACH TO DO IT IN SECONDARY EDUCATION
María del Carmen TORRES CARRERO Esther PONCE BLÁZQUEZ Francisco Javier SÁNCHEZ-VERDEJO PÉREZ María Jesús MARTÍNEZ OCAÑA	University of Castilla-La Mancha	COOPERATIVE LEARNING AND DIGITISATION: INNOVATIVE STRATEGIES FOR THE DEVELOPMENT OF LINGUISTIC COMPETENCE IN PRIMARY EDUCATION
Juana María ANGUITA ACERO María del Carmen DEL AMO CHICHARRO Eduardo LÓPEZ BERTOMEIO Ángel Luis GONZÁLEZ OLIVARES	Complutense University of Madrid University of Castilla-La Mancha	TECHNOLOGY AND MOTIVATION. KEY ELEMENTS IN TEACHING-LEARNING PROCESSES

 DATE	• 25.01.2024	 TIME	• 14⁰⁰–16⁰⁰	 SESSION	• HALL-6 • SESSION-3
--	---------------------	--	--	---	---------------------------------------

HEAD OF SESSION:

Asad Ullah Ubaid Ur Rahman Aleena Hammad Ali Prof. Dr. Abbas Khan	Abdul Wali Khan University Mardan	FACILE SYNTHESIS AND CHARACTERIZATION OF MANGANESE DIOXIDE DECORATED GRAPHENE OXIDE FOR ENHANCED PHOTO CATALYTIC APPLICATIONS OF CONGO RED DYE
Akbar Ali Hina Anwar Muhammad Ibrahim Muhammad Saeed	Government College University	A STEPWISE VS. ONE POT ESTERIFICATION- CLICK (CuAAC) APPROACH TO SYNTHESIZE NEW BENZO[H]CHROMENE HYBRID COMPOUNDS VIA CYCLIZATION OF LAPACHOL
Sabri Mohamed M'hamdi Zakya Elhourri Mohammed Amechrouq Ali Said Chakir	University Moulay Ismail Laboratory of Molecular Chemistry and Natural Substances	PHYTOCHEMICAL STUDY AND EVALUATION OF ANTIOXYDANT ACTIVITY OF CROCUS SATIVUS METHANOLIC EXTRACT FROM THE MORROCO REGION
Arooj Anwar Fozia Anjum Muhammad Shahid Samreen Gul Khan	Government College University University of Agriculture	PREPARATION OF HEALING AGENT FROM MURRAYA KOENGII TO TREAT BURN INFECTION
Z. Kovziridze N.Nijaradze G. Tabatadze T. Cheishvili Ts. Danelia N. Darakhvelidze M. Balakhashvili S. Gvazava.	Georgian Technical University	SMART NANOCOMPOSITE IN THE TiC-BN-SiC-B ₄ C-SiAlON-Al ₂ O ₃ SYSTEM FOR TURBINE DISKS AND WINGS, BALLISTIC ARMOR, FOR WORKING IN HOT NODES OF FLYING MACHINES
Chennai Yasmine Ouassaf Mebarka Belaidi Salah Lotfi Bourougaa	University of Biskra	IDENTIFICATION OF SELECTIVE INHIBITORS FOR HIV1 USING E-PHARMACOPHORE MODELLING AND LARGE-SCALE VIRTUAL SCREENING-BASED STRUCTURE GUIDED DRUG DISCOVERY APPROACHES
M.A.A. Zaini	Universiti Teknologi Malaysia	ACTIVATED CARBON FROM BIOMASS - PREPARATION, CHARACTERIZATION AND APPLICATIONS

CONTENTS

AUTHOR	TITLE	No
Tahir Balcı Munise Aksöz	CULINARY LINGUSTICS OR FOOD AND BEVERAGE LINGUSTS	1
Gamze KARS Nevin GÜNAYDIN	PERCEIVED STRESS IN NURSES AND METHODS OF COPING WITH STRESS	8
Süreyya Karsu	INNOVATIVE ENERGY, HYDROGEN and TÜRKİYE's ASPECT	19
Tahir Balcı Munise Aksöz	FEATURES OF GERMAN AND TURKISH IN TERMS OF SEPARATING SYLLABLES	30
Gamze KARS Nevin GÜNAYDIN	RISK FACTORS ASSOCIATED WITH POSTPARTUM DEPRESSION	37
Mohd Khairul Nizam ISMAIL Herman Shah ANUAR Faisal ZULHUMADI	STRATEGIC PROCUREMENT IN MALAYSIA AUTOMOTIVE INDUSTRY: KEY CRITERIA FOR SUPPLIER SELECTION PROCESS BY TIER ONE SUPPLIER	43
ABDUL-KARİM, I. F. SUBAİR, S. K. YUSUF, O. J. ADEFALU, L. L.	CONSTRAINTS TO ADOPTION OF EXPORT STANDARD PRACTICES (ESP) AMONG COFFEE-BASED FARMERS IN KOGI STATE, NIGERIA	58
Ahmet AKIN Orçun Dirik	DOMESTIC MOBING SCALE: VALIDITY AND RELIABILITY STUDY	88
Ahmet AKIN Zehra SAÇMALI	TRUST IN THE FAMILY SCALE: VALIDITY AND RELIABILITY STUDY	93
Neha Kamboj Rahul Kumar Pankaj Gautam Navin Kumar	PLANT AND ANIMAL BASED ANTIMICROBIAL PEPTIDES	97
Zeynep POLAT Önder EKİNCİ	EVALUATION OF URBAN STORMWATER DRAINAGE SYSTEMS IN THE CASE OF YALOVA	107
Emre ŞENAY Özgür AKPINAR	NATURAL DISASTER INSURANCE, TURKEY AND JAPAN COMPARISON	119
Natalia Bolgari Ina Andoni	ENHANCING BUSINESS ENGLISH TEACHING THROUGH MULTIMODALITY: A PRACTICAL APPROACH	138
Kai Ge Bai Kim Hua Tan Mohd Nor	EXPLORING CHATGPT TECHNOLOGY AND METAVERSE IN FUTURE INTERPERSONAL COMMUNICATION SCENARIOS: BASED ON THE S-O-R MODEL	147
Shuaeeb, A. I. Mufidat, A. A. Kabir, I. M. Yaki, A. A. Babagana, M.	ASSESEMENT OF AWARENESS AND KNOWLEDGE OF ECO-LITERACY CONCEPTS AMONG PRE-SERVICE SCIENCE TEACHERS OF FEDERAL UNIVERSITY OF TECHNOLOGY, MINNA	156
Mustafa Fahri Kuvan	PROCESSING OF PERSONAL DATA ABOUT THE EMPLOYEE BY THE EMPLOYER, VIOLATIONS AND SANCTIONS	167

Sabina GARASHOVA	ARMENIANISM IN MODERN ARMENIA: FROM THE PERSPECTIVE OF INTERNATIONAL RELATIONS	182
Nodar Sulashvili Nato Alavidze Ekaterine Lomia	THE SCIENTIFIC TALKS OF THE FEATURES OF IMPACT OF DIGITAL HEALTH FROM PHARMACY PRACTICE AND HEALTH CARE POLICY PERSPECTIVES	192
Said Yaşar DEMİRÖZ	THE IMPACT OF ARTIFICIAL INTELLIGENCE TECHNOLOGIES ON COMBATING THE INFORMAL ECONOMY IN TURKISH LAW	206
Günel HACIYEVA	MASTERING ENGLISH IDIOMS IN TERMS OF PRACTICAL COMMUNICATION AND THE FORMATION OF SKILLS FOR THEIR EFFECTIVE USE	229
Deborah Dara Oladeji	INFLUENCE OF TURMERIC RHIZOME (<i>Curcuma longa</i> Linn) POWDER ON THE HISTOPATHOLOGY OF BROILER CHICKENS AT FINISHING PHASE	236
Həsənova Daşdəmirova	AZƏRBAYCAN MÜASİR İQTİSADI İNKİŞAF YOLUNDA	245
Ahmet AKIN Selin Cennet TÜRKER	LOYALTY SCALE IN ROMANTIC RELATIONSHIPS: VALIDITY AND RELIABILITY STUDY	252
Tayfur Can Nevin Günaydın	MENTAL HEALTH LITERACY	258
Saja Murtadha HASHIM Kürşat Mustafa KARAOĞLAN	ADVANCES IN NAME ENTITY RECOGNITION: EXPLORING STATE-OF-THE-ART METHODS	265
Serap ERÇİN KOÇER	OLD MOSQUE OF DÜZKIŞLA VILLAGE IN BANAZ DISTRICT OF UŞAK PROVINCE	285
Aybegüm Güngördü Belbağ Sedat Belbağ	INTENTION TO USE MOBILE PAYMENTS DURING THE PANDEMIC: A SYSTEMATIC LITERATURE REVIEW	295
Sürreya KAVAL	ANALYSIS OF THE FAIRY TALE NAMED HEZALOK AND DELALOK FROM SYRT ARAB FOLK TALES WITH VLADIMIR PROPP'S FAIRY TALE ANALYSIS METHOD	303
Recep BİLGİN	DEFINITION, VALUE AND PLACE OF TALFİK AL-ISNĀD IN HADĪTH METHODOLOGY	321
Thëllëza Latifi Sadrija Behrije. Behrije Ramaj Desku	THE IMPORTANCE OF BUSINESS COMMUNICATION IN THE DIGITAL AGE	328
Tamar Okropiridze Nodar Sulashvili	THE MANIFESTATION OF CHARACTERISTICS PERIODONTAL DISEASES IN CHILDREN VS THE BACKGROUND OF SOMATIC DISEASES	336
Nato Alavidze Nodar Sulashvili	THE MANIFESTATION OF FEATURES OF PROBLEM-BASED LEARNING IN PHARMACOLOGY, A SURVEY OF DEPARTMENT HEADS IN GEORGIAN MEDICAL UNIVERSITIES	356

Nodar Sulashvili Nato Alavidze Ekaterine Lomia	THE MANIFESTATION OF THE SCIENTIFIC DISCUSSION OF PHARMACEUTICAL EDUCATION OPPORTUNITIES AND SPECIFIC PROFESSIONAL FEATURES OF THE JUNIOR PHARMACISTS IN GEORGIA	365
Tsegmid Namsrajav	WINTER BIRDS IN THE TRANS-ALTAI GOBI DESERT	381
Vaanie Godbole Pankaj Gautam Manoj Kumar Pal	POTENTIAL OF MICROALGAE IN MICROBIAL FUEL CELLS (MFCS): A REVIEW	385
Sevde KURT Aydn KAVAK	ANALYSIS OF BUILDING PILE SOIL INTERACTION WITH PLAXIS 3D PROGRAM	394
Tayfur Can Nevin Günaydn	GENERALIZED ANXIETY DISORDER	402
Muhammad Aminu Musa Bashir Muhammad Ashir	EVALUATING THE EFFECTS OF VARIOUS COOLING TECHNIQUES ON ENERGY EFFICIENCY OF LIBRARIES IN THE HOT AND DRY CLIMATE OF NIGERIA	410
Temel SARIYILDIZ	NUTRIENT INPUTS BY LITTERFALL INTO ECOSYSTEMS IN ASH TREE STANDS AT BURSA KARACABEY FORESTED WETLANDS	416
Maina, M. Oladimeji, Y. U. Abdulrahman S. Hussaini, A.S. Shuaibu, H.	ANALYSIS OF DIRECTON OF PRICE TRANSMISSION AND COMPETITIVENESS AMONG FERTILIZER VALUE CHAIN ACTORS IN KADUNA STATE, NIGERIA	424
Olatoye, F. C. Oladimeji, Y. U. Sanni, S. A. Abdulkadir, A.	ANALYSIS OF FARM HOUSEHOLDS' PRODUCTIVITY ON IDENTIFIED AGROFORESTRY PRACTICES IN OYO STATE, NIGERIA	432
Ayethan Ziyad Zemfire Shirinova	HAYDAR ALİYEV: PRIDE OF OUR NATIONAL IDENTITY	440
Temel SARIYILDIZ	INVESTIGATION OF LITTER CARBON AND NUTRIENT STOCKS IN ASH TREE STANDS AT BURSA KARACABEY FORESTED WETLANDS	447
Meryem BASATEMÜR Nezihe OTAY LÜLE	NUTRITIONAL SUPPLEMENT AFTER BARIATRIC SURGERY	457
Cavadov Radin Xaləddin oğlu	SOCIAL LIFE OF THE POPULATION OF IRAVAN GOVERNANCE: EDUCATION, RELIGION AND CULTURE	469
Deniz HAZAR Nezihe OTAY LÜLE	NUTRITIONAL SUPPLEMENT IN ELDERLY	477
Hayri AĞAN	A SPACE FOR THE VISIBILITY OF YOUNG ARTIST CANDIDATES: BASE 2023 IN THE CONTEXT OF PAINTING	490
erman Shah Anuar Kyle Tan Jin Soon	JOB SATISFACTION AMONG YOUTH IN MALAYSIA OIL AND GAS INDUSTRY	504
Öznur ÇINAR	EVALUATION OF PSYCHOSOCIAL ACTIVITIES APPLIED AFTER 2023 KAHRAMANMARAŞ EARTHQUAKES	514

Mehmet ÜNAL Halis DEDE	COMPARATIVE CRITICISM OF FAİK REŞAD'S "TÂRÎH-I EDEBÎYYÂT-I 'OSMÂNİYYE" WITH LATIFI'S "TEZKİRETU'Ş-ŞUARÂ"	526
Halis DEDE Mehmet ÜNAL	GENERAL SYNTAX DISEASES THAT ARE FAMOUS AND FOCUSED ON IN THE ARABIC LANGUAGE	535
Nazila Ragimova Kamenieva Nina Almammadova Mehriban	STUDY ON TRAINING APPROACH PERSONNEL OF AUTOMATED CONTROL SYSTEMS WITH THE PURPOSE OF IMPROVING AND INCREASING THE RELIABILITY OF THE SYSTEMS IN CONSIDERATION DURING THEIR DESIGN	541
Andrey Popatanasov Ilza Pujeva Luybka Tancheva Reni Kalfin	BIOPHYSICAL MODELLING OF THE NEUROTENSIN RECEPTORS NTS1 IN RATTUS NORVEGICUS AND MUS MUSCULUS	547
Fitnat Şule ŞAKAR Melikenur TÜRKOL	THE ROLE OF WEIGHT MANAGEMENT AND DIETITIAN	553
Eda EYİ	THE EFFECTS OF CHANGING AND NOT CHANGING THE ALPHABET ON TURKISH SOCIETY	562
Ayhan KARAKAŞ Ahmet ASLAN Halim AKBULUT	THE EFFECT OF PERCEIVED ORGANISATIONAL SUPPORT ON ORGANISATIONAL COMMITMENT: A STUDY ON RESTAURANT EMPLOYEES	571
Yeliz ALNAK Koray KARABULUT	EVALUATION OF MULTI-IMPINGING JET FLOW EFFECT IN COOLING OF VARIOUS GEOMETRIC MODEL SURFACES	581
Muhammet Faruk KARAÇ Mehmet Ufuk ULUĞ Yusuf Özkan ÖRNEK Canan PERDAHÇI	HUMAN DETECTION WITH ANALOG PIR SENSOR	595
TUBA ÇETOK	TRANSFORMATION OF THE NARRATED WOMAN INTO THE NARRATING WOMAN: THE STORY OF UNACCEPTABLE FEMININITY IN THE NOVEL YUSUF İLE ZÜLEYHA	608
Güllər BAĞIROVA	INCREASING LOGISTICS RELATIONS BETWEEN AZERBAIJAN AND TURKEY	617
Arzu BAYKARA TAŞKAYA	CHOLERA CASES ON THE ISLAND OF MALTA (1867-1910)	623
Yağmur KÖFTER KURT	19TH CENTURY TURKISH CEMETERY CULTURE THROUGH THE EYES OF FORIGN VOYAGERS TRAVELLING TO THE OTTOMAN EMPIRE	647
Bayram Sönmez ÜNÜVAR	THE CONTENT QUALITY AND READABILITY OF THE PATIENT INFORMATION TEXTS ON TURKISH WEBSITES REGARDING EXERCISES FOR LOWER BACK PAIN	654
Batuhan ZEYREK Erdoğan DOĞANCI Merve DANDAN DOĞANCI	OBTAINING THERMOPLASTIC COPLIESTER ELASTOMER (TPE) SURFACES AND EXAMINING THEIR FREE SURFACE ENERGIES	662

Hatice Kübra GÜNDÜZ Meltem ERBAŞ ÖZİL	EVALUATION OF DIYARBAKIR KINDERGARTEN WITHIN THE SCOPE OF MONTESSORI METHOD SPATIAL PRINCIPLES	668
İlker ŞEN Nazlı BÜYÜKYILDIZ M. Akif ÇATAK	TREATMENT OF TEMPOROMANDIBULAR JOINT LUXATION IN A CAT: CASE REPORT	678
Bekir Can ÇİBUK İbrahim Can AYDIN Vural AKTÜRK	APPLICATION OF THE TOWING SYSTEM TO THE LF12 VEHICLE	686
Sezgin DÜZCE Duygu SÖNMEZ DÜZKAYA Atiye KARAKUL	EARLY MOBILIZATION IN THE PEDIATRIC INTENSIVE CARE UNIT	695
Okan GÜDER Yasemin ÇETİN KAYA	CLASSIFICATION OF SKIN LESIONS	702
Məmmədov Jahan Siraj gizi Mammadova Məhəmməd Abduyev	BÖYÜK QAFQAZIN ŞİMAL-ŞƏRQ HISSƏSİNİN MÜASİR LANDŞAFTLARININ FORMALAŞMASINA TƏSİR EDƏN AMİLLƏR	711
Abdullah E. AKAY	USE OF REAL-TIME UAV IMAGES IN SAFE ACCESS TO FIRE AREAS IN THE SHORTEST TIME	715
Mihdat AKTULGA	THE IMPORTANCE OF SACRED TIMES IN TERMS OF SIN AND SALVATION IN DUALIST AND MONOTHEIST RELIGIONS	724
Tuğrul YAĞBASAN Hayati TÜRE Metehan Murad TALİ	IOT SECURITY WITH ELASTIC STACK AND MACHINE LEARNING: INTELLIGENT DEFENCE SYSTEM AGAINST DOS ATTACKS	731
İdris Demirsoy	A MACHINE LEARNING APPROACH TO DETERMINE OPTIMAL TOGG SALE PRICE IN THE EUROPEAN MARKET	739
Allahverdiyev Pərviz Rəşad oğlu Əlixanov Valeh Məmməd oğlu	QARABAĞ TORPAQLARININ İŞXALDAN AZAD EDİLMƏSİ KEÇMİŞİMİZDƏN BU GÜNÜMÜZƏ	750
Emre Karakaya Bilgehan KEKEÇ Niyazi BİLİM	THE RELATIONSHIP BETWEEN TEXTURE COEFFICIENT (TC) VALUES OF MAGMATIC ROCKS AND BÖHME ABRASIVENESS VALUES	756
Cavadov Radin Xələddin oğlu Javadov Radin Khaleddin oghlu	TERRITORY AND ADMINISTRATIVE SYSTEM OF IRAVAN GOVERNANCE	769
Javid YUSUBOV	EVOLUTION OF POLITICAL SYSTEMS IN POST-SOVIET NATIONS AMIDST THE EMERGING GLOBAL ORDER	782
Anupam Khanna DAV College Sadhaura Yamunanagar Haryana BHARAT	CHALLENGES IN PUBLISHING RESEARCH PAPERS IN JOURNALS	791
Ananda Majumdar	EFFECTIVENESS OF DIGITAL LITERACY IN THE CONTEMPORARY ERA	796

Duygu Dertli Ayşe Abit Kocaman Ayla Çağlıyan Türk	EXAMINATION OF THE RELATIONSHIP BETWEEN BODY IMAGE DISTURBANCE, SPINAL MOBILITY AND QUALITY OF LIFE IN ADOLESCENTS WITH IDIOPATHIC SCOLIOSIS: A PILOT STUDY	809
Enes KAVAK Hacı BODUR	ANALYSIS OF A 1/8 BRICK-SIZED, HIGH- POWER DENSITY AND FOUR-SWITCH BUCK- BOOST DC-DC CONVERTER FOR MILITARY AVIATION APPLICATIONS	816
Truong Chanh Duc	ENSURING FACTORS FOR THE IMPROVEMENT OF LEGAL PROVISIONS REGARDING THE ESTABLISHMENT OF WORKERS' ORGANIZATIONS IN ENTERPRISES IN VIETNAM TODAY	829
Güllü YAZKAN Nezihe BULUT UĞURLU Fatma BİRGİLİ Feyza ACAR	ANTİPSİKOTİK İLAÇLARIN YAN ETKİLERİNDEN EKSTRAPIRAMİDAL SENDROM VE HEMŞİRELİK BAKIMI	837
Erkan DİKİCİ Necla KARA	PSYCHOSOCIAL ASSESSMENT OF RETURN OF DUTY PERSONNEL	845
Ufuk TÜRELİ Mehmet Oğuz KELEK	ESTIMATION OF SPECTRUM USAGE WITH MACHINE LEARNING ALGORITHMS	860
Fatma YILMAZ DAĞNIK Gencay KARAKAYA	AN OVERVIEW OF THE AUTHORIZED ECONOMIC OPERATOR STATUS IMPLEMENTED WITHIN THE CONTEXT OF TRADE FACILITATION IN TURKEY	871
Mehmet AKIN Şafak ULUÇINAR SAĞIR	DETERMINATION OF SCIENCE TEACHERS' OPINIONS ABOUT ARGUMENTATION-BASED LEARNING	887
Aziz Kürşat KILIÇDAĞI Fikriye YALÇINKAYA Derya BAYRAKTAR Ahmet Sencer YURTSEVER Kansu BÜYÜKAFŞAR	ESTROGENIC SUBSTANCES OF DIETARY ORIGIN AND POSSIBLE ROLE OF GPER-1 RECEPTOR IN THEIR ADIPOGENIC EFFECTS	900
Muhammad Aminu Musa Bashir Muhammad Ashir	EVALUATING THE EFFECTS OF VARIOUS COOLING TECHNIQUES ON ENERGY EFFICIENCY OF LIBRARIES IN THE HOT AND DRY CLIMATE OF NIGERIA.	913
Arunabh Shrivastava	“HARMONIZING CYBERSPACE AND INTELLECTUAL PROPERTY: UNVEILING COMPLEXITIES, NAVIGATING CHALLENGES, AND CHARTING FUTURE COLLABORATIONS”	918
Muhammad Aminu Musa Bashir Muhammad Ashir	EVALUATING THE EFFECTS OF VARIOUS COOLING TECHNIQUES ON ENERGY EFFICIENCY OF LIBRARIES IN THE HOT AND DRY CLIMATE OF NIGERIA	925
Arunabh Shrivastava	“HARMONIZING CYBERSPACE AND INTELLECTUAL PROPERTY: UNVEILING COMPLEXITIES, NAVIGATING CHALLENGES, AND CHARING FUTURE COLLABORATIONS”	930

Hüseyin Ertan İnan	EVALUATION OF SERVICE QUALITY IN FITNESS CENTERS: ANALYTIC HIERARCHY PROCESS APPROACH	937
Esra ARSLAN YÜKSEL	ESTIMATION OF ALLEVIATIVE EFFECT OF TANNIC ACID ON GENOMIC INSTABILITY IN CHROMIUM-TREATED ZEA MAYS	945
Adama Solomon Bake Muhammed Adamu Zubairu Adegoko Abiola Rhodiyat Mohammed Yakubu Manbe Musa Bulus	ASSESSMENT OF ARTISANAL MINING ACTIVITIES IN SELECTED STREAMS IN MAIWAYO-KATAEREGI AREA IN NIGER STATE, NORTH CENTRAL NIGERIA	950
Adama Solomon Bake Muhammed Adamu Zubairu Abdulsalam Rahinat Mohammed Yakubu Manbe Saba Jonathan Jiya	PREVALENCE OF MYCOTOXINS IN DRIED FISH AND FOOD SAFETY IN NIGERIA	958
Ali Ihsan KAYA	NATURAL FREQUENCIES INVESTIGATION OF CURVED JOINTS WITH RESPECT TO DIFFERENT CURVATURE ANGLES	972
Ahmad Sawy Khaled Ali Muhammad Noman Saeed	ENHANCING ACADEMIC EXCELLENCE: A COMPREHENSIVE STUDY OF TRAINING AND DEVELOPMENT IN JAZAN UNIVERSITY THROUGH THE IMPLEMENTATION OF A TRAINING MANAGEMENT SYSTEM DURING THE ACADEMIC YEAR	979
Gamze GÖKTEPELİ Esra YEL	EFFECT OF CATALYTIC PYROLYSIS CHAR ON POLYPROPYLENE HYBRID COMPOSITES	988
Gamze GÖKTEPELİ	EFFECT OF DIFFERENT PRE-TREATMENTS ON THERMAL PROPERTIES OF SUNFLOWER SEED HUSK HYDROCHARS	996
Göksu KUNT Halil SEVİM	MATERIAL SELECTION IN INTERIOR DESIGN OF HEALTHCARE BUILDINGS	1002
Gülsüm GÖKTAŞ Gülbin ZEREN NALINCI	EVALUATION OF SCIENTIFIC STUDIES EXAMINING THE EDUCATIONAL EFFECTS OF CREATIVE DRAMA ACTIVITIES ON TEACHER CANDIDATES	1013
Muhittin Eliaçık	A COMPILATION ON WORDS OF HAZRAT ALI	1029
Muhittin Eliaçık	VERSE CATECHISM TEXT BY AN UNKNOWN AUTHOR	1035
Kadir VARDAR	INVESTIGATION OF THE EFFECT OF DEAD TIME IN INDIRECT FIELD ORIENTED CONTROL OF INDUCTION MOTOR	1045
Yıldırım İsmail Tosun	SAWING DISC TEST FOR ROCK FALLING RISK OF ŞIRNAK ASPHALTITE QUARRY - STUDY ON CEMENTED CRACKS OF SHALE, MARLY CLAYSTONE FOR UPPER SLOPE'S STABILITY	1056
Yıldırım İsmail Tosun	MICROWAVE AUTOPYROLYSIS OF COAL IN BUBBLING FLUIDIZED BED BY CA - FERRITE/SERPENTINITE FINE	1065

Neslihan Mutlu	CHITOSAN IN MICROBIAL BIOTECHNOLOGY: MULTIFACETED APPLICATIONS AND SUSTAINABLE SOLUTIONS	1075
Recep EKİCİLER	EXPLORING THE POTENTIAL OF FLOW AND HEAT TRANSFER CHARACTERISTICS OF TETRA NANOFLUID (AL ₂ O ₃ -TiO ₂ -AU- AG/WATER) IN A CHANNEL	1083
Selda KARADAĞ Turgut KIRMIZIBAYRAK	GOOSE AS AN INCREASINGLY POPULAR POULTRY IN TÜRKİYE	1095
Osman İlker AÇIKGÖZ Selim TANGÖZ	FAN BLADE BALANCING ON AIRCRAFT ENGINES AND ITS APPLICATION ON CF6 ENGINES	1102
Metin YILDIRIM	THE WORK CALLED RELIGIOUS AND LITERARY HASBİHÂLLER, BY ISPARTALI ZEYNELÂBİDİN BEY, AN AUTHOR WHO HAS ESCAPED	1113
Erdal Tunçer Murat Hüseyin Kumkale Tayfun Pektaş Diñçer AKAL	THE EFFECT OF USING BIODIESEL PRODUCED FROM WASTE OILS IN A DIESEL ENGINE ON ENGINE PERFORMANCE AND EMISSIONS	1120
Ali İhsan MENEVŞE Eralp ŞENER Işıl YAZAR	ELECTRICAL SYSTEM DESIGN AND MATHEMATICAL MODELLING FOR BATTERY SUPPORTED PROPULSION SYSTEM FOR AIRCRAFT TAXIING	1130
Hande BULDUK	FICTIONAL FUNCTION OF SUPERSTITION ELEMENTS IN THE NOVELS OF SELÂMÎ İZZET SEDES	1138
Merve BALABAN Gökhan UÇAR Emre DANDIL	AUTOMATED DETECTION OF ISCHEMIC STROKE LESIONS USING U-NET DEEP LEARNING ARCHITECTURE IN BRAIN MR SCANS	1147
İSA ŞAHİN Mehmet Ufuk ULUĞ	HC-06 BLUETOOTH MODÜLÜ VE WİFİ ÜZERİNDEN AKILLI İNTERKOM HABERLEŞME DEVRESİ	1162
Muhammad Kabiru Abubakar	ISOLATION AND IDENTIFICATION OF FUNGI IN MILLET DOUGH BALLS (FURA) SOLD AT KAZAURE METROPOLIS, JIGAWA STATE, NIGERIA	1172
Kennedy Aaron AGUOL	LUYANG PRECINCT FOOD SCENE AND PRACTICES: LINKING CONTEMPORARY FOODS AND COMMUNITIES ACTIVITIES TO THE PAST	1178
Muhammad Aminu Musa Lawal Ahmed Tanimu	A HISTORICAL LANDMARK AND A SYMBOL OF RESPECT FOR THE ZARIA TRADITIONAL INSTITUTION: KAFEN DAUDU	1196
Bünyamin ÖZER Sevinç Ay Derya AVCI	BRAIN TUMOR CLASSIFICATION WITH DECISION SUPPORT SYSTEMS	1208
Ahmet TEKİN Arif GÜRSOY	AN IMPROVED BINARY INTEGER PROGRAMMING MODEL OF THE BAND COLLOCATION PROBLEM WITH LIMITED RESOURCES	1220

Aylin BİLGİN	DETERMINING THE RELATIONSHIP BETWEEN GASTROINTESTINAL SYMPTOMS AND COMFORT IN INFLAMMATORY BOWEL PATIENTS	1230
Mustafa DURAN Eray KÖKSAL Çağlar BAYIK	DEM PRODUCTION AND ACCURACY ANALYSIS BY INTERFEROMETRIC METHOD USING KOMPSAT-5 SAR IMAGES	1236
Temur Kopadze	MULTISYSTEM EFFECTS OF GOUT ON THE BODY	1259
Osman AHLATLI H. İbrahim KARAOKUR Emrah GÖNEN	IMPROVEMENT OF A SYSTEM PROVIDING HOMOGENEOUS AIR SUCTION ON THE DRUM FOR A MACHINE THAT RECYCLES FIBERS FROM FABRIC AND FIBER	1264
Kübra DİNÇSOY	ON THE WORK OF AHMED BİN ABDÜ'L-CEBBÂR'S TUHFETÜ'L-MÛLÛK	1276
Talat Taha GÖKÇE Oğuzhan ARI	LF12 VEHICLE E-MIRROR APPLICATION	1281
Sedat BAYARAL Sevinç AY Derya AVCI	DETECTING HEART DISEASE USING MACHINE LEARNING MODELS	1292
Mihdat AKTULGA Nurettin AKCAN	THE FIGURE OF 'JESUS THE SAVIOR' IN MANICHEISM	1308
KANTAOUİ Aicha BOUDRIES Hafid LARICHE Nesrine	OPTIMIZATION OF THE EXTRACTION OF BIOACTIVE COMPOUNDS FROM PRUNUS FRUIT	1314
Menderes KURT	THE TRANSFORMATION YEARS OF THE MIDDLE EAST: "WHAT DOES 'DETENTE' MEAN FOR THE REGION?"	1324
Nail DEMİRCİ Batın DEMİRCAN	DEVELOPMENT OF MICRO COGENERATION SYSTEM WITH DIESEL GENERATOR	1332
Əbilov Rəşad Səffan oğlu Əliyeva Pərvin Zakir qızı	SCIENTIFIC JUSTIFICATION OF THE ESTABLISHMENT OF MIRIK SMALL WATER POWER STATION ON ZABUKH RIVER, LACHIN DISTRICT	1347
Dilek Özlem ESEN Murat YÜCEL	THEORETICAL INVESTIGATION OF THE EFFECT OF THE USE OF BIOFUELS IN DIESEL ENGINES ON ENGINE PERFORMANCE AND EMISSIONS	1364
Eda EYİ	THE METHOD OF VERIFICATION TURKISH LANGUAGE: ON THE BENEFITS OF TEACHING TURKISH GRAMMAR WITH "OKLAMA"	1373
Ömer Faruk TAVŞANLI	WAYS OF PRIMARY SCHOOL STUDENTS SHOWING THEIR EDITORIAL SKILLS ACCORDING TO THE OWNER OF THE PAPER: SOCIAL AUTHORITY IN WRITING	1380
Emrullah FATİŞ	THEOLOGICAL PERSPECTIVE ON SOME BELIEF PERCEPTIONS OF SULEIMANISTS	1386
Emrullah FATİŞ	CELÂLEDDİN DEVVÂNÎ'S APPROACH TO SOME THEOLOGICAL AND PHILOSOPHICAL PERCEPTIONS	1396

Nisbet MEHDİYEVA	THE SCIENCE IN BASHKORTOSTAN (XIX – BEGINNING OF XXTH CENTURY)	1404
Güllü YAZKAN Nezihe BULUT UĞURLU Fatma BİRGİLİ Feyza ACAR	PSİKOSTİMÜLAN MADDELER VE PSİKOSOSYAL HEMLİRELİK BAKIMI	1411
İsa ÇİÇEK Merdin DANIŞMAZ	NUMERICAL INVESTIGATION OF THE USE OF WATER-BASED AL ₂ O ₃ NANOFUID AS REFRIGERANT IN PHOTOVOLTAIC THERMAL PANELS	1419
Səriyyə Abidova Elşən qızı	QUBA QƏZASINDA OLAN ERMƏNİ VƏHŞİLİKLƏRİ AZƏRBAYCAN QƏZETİNİN SƏHİFƏLƏRİNDƏ	1434
Bekir Can ÇİBUK İbrahim Can AYDIN Ahmet ÖZCAN	IMPLEMENTATION OF LF25 METROBUS VEHICLE DRIVER SAFETY BELT CONNECTION WITHIN THE SCOPE OF R14 REGULATION	1439
Meltem KARAHAN Bahar Başak KIZILTAN ELİAÇIK	DO COLORS AND MUSIC HAVE AN IMPACT ON DENTAL ANXIETY?	1449
Meeta Saxena	EFFECT OF RADIATION ON OPTICAL, ELECTRICAL AND STRUCTURAL CHARACTERIZATION OF MNA DOPED PS: PVS POLYBLENDS	1460
Abdullah E. AKAY	EVALUATION OF THE EFFECTS OF FOREST ROAD STANDARDS ON TRANSPORTATION SAFETY	1468
Öznur ÇINAR	MONITORING THE CONCEPTUAL RESEARCH OF FLOOD AND TORRENT EVENTS	1477
Sena ÖZDİL Sema SAMATYA YILMAZ Merve DANDAN DOĞANCI Erdoğan DOĞANCI	PREPARATION OF TETRA-N-BUTYLAMONIUM HYDROGEN SULFATE QUATERNARY AMMONIUM SALT ADDED ANTIBACTERIAL EFFECTIVE WOUND DRESSING	1489
Mehmet AKIN Gülbin Zeren NALİNCİ	CLASSROOM TEACHERS'S VIEWS ON THE CREATIVITY OF PRIMARY SCHOOL STUDENTS	1497
Serap UZUNER YURT Ebru BUYURMAN Elif Nur DERVİŞ Özlem TANOĞLU Rüya Ece AKTAŞ Sümeyye Burcu GÜLTEKİN	YARATICI DRAMA ATÖLYELERİNE KATILAN 6.SINIF ÖĞRENCİLERİNİN SAVAŞ VE GÖÇMEN KAVRAMINA İLİŞKİN METAFORİK ALGILARI	1507
Kıvanç UZUN Muhammet TORTUMLU	THE MODERATING ROLE OF GENDER IN THE IMPACT OF YOUNG ADULTS' CAREER OPTIMISM ON THEIR SELF-FORGIVENESS TENDENCIES	1520
Erol AKCAN	THE MURDER OF HALIT PASHA AS A HISTORICAL EVENT AND FROM THE PERSPECTIVE OF TURKISH HISTORIOGRAPHY	1533

İrem AKOY Duygu SÖNMEZ DÜZKAYA Atiye KARAKUL	(PREVENTIVE AND REHABILITATIVE NURSING CARE FOR RESPIRATORY SYSTEM DISEASES IN CHILDREN)	1543
Ayşenur DAYAN Banu TERZİ	HEMŞİRELİK TEMEL BECERİLERİNİN ÖĞRETİMİNDE SANAL GERÇEKLIK KULLANIMININ ÖĞRENCİLERİN BİLGİ, DUYUSAL VE PSİKOMOTOR BECERİLERİNE ETKİSİ: SİSTEMATİK DERLEME	1555
Serda DURMUŞ KELEŞ Gülzade UYSAL	TECHNOLOGY ADDICTION IN CHILDREN	1566
Tarkan ÖZTÜRK	INVESTIGATION OF COMMUNICATION METHODS BETWEEN VIRTUAL ENVIRONMENTS AND USERS IN DIGITAL GAMES	1575
Muhammet KOCAMAN	CURRENT SITUATION OF OLTU STONE CARVING, A TRADITIONAL TURKISH CRAFT	1582
Serda DURMUŞ KELEŞ Gülzade UYSAL	A CHILD WITH ACUTE DISSEMINATED ENCEPHALOMYELITIS AND NURSING CARE: CASE REPORT	1597
Gürhan Uysal	İŞLETMENİN SÜRDÜRÜLEBİLİRLİĞİ: İKY VE İK MATEMATİĞİ30	1607
Hasan KEMALOĞLU Mehmet Emin USTA Ümit DOĞAN	OPINIONS OF TEACHERS AND ADMINISTRATORS ON THE PROBLEMS AND DIFFICULTIES ENCOUNTERED IN SCHOOLS WHERE DIFFERENT LEVELS PROVIDE EDUCATION IN THE SAME BUILDING	1616
Mustafa KARABULUT	EDİP CANSEVER'S CONTRIBUTIONS TO TURKISH	1631
Mustafa KARABULUT	NECİP FAZIL KISAKÜREK'S CONTRIBUTIONS TO TURKISH	1638
Bilge Özkaymak	PASSIONATE TANGO MADE BY VISUALITY WITH TASTE: MARKIZ (LEBON) PATISSERIE	1644
Yunus Emre GÜNDOĞAN Umut ALMAÇ	TEKIRDAG INONU MIDDLE SCHOOL: CURRENT STATE, CONSERVATION ISSUES AND PROPOSALS	1661
Oladeji A. OLATUNJI Ganiu O. OKUNNU	SURVEILLANCE IN THE AGE OF THE INTERNET: THE DEATH OF CIVIL LIBERTY	1668
Radoslav Baltezarević Ivana Baltezarević	THE MACROECONOMIC ADVANTAGES OF HIGH-QUALITY EDUCATION44	1676
Namig Bağirli	THE SIGNIFICANCE AND IMPORTANCE OF GENOCIDE MEMORIAL COMPLEXES	1682
Najafgulieva P.H. Gasimov R.Sh.	THE RESULTS OF THE SURGICAL TREATMENT OF PARASTOMAL HERNIAS PERFORMED AT THE AZERBAIJAN MEDICAL UNIVERSITY	1686
Esmâ ERTEKİN Murat YORULMAZ	HISTORICAL DEVELOPMENT AND EVALUATION OF TURKISH SHIPPING AGENCY	1691
Okan DİNÇ Ramazan Furkan KOCA	HIGH EFFICIENCY LIQUID FUEL HEATING SYSTEMS IN DEFENCE INDUSTRY	1707

Halil İbrahim BİNİCİ	A NEW FOOD PROCESSING TECHNIQUE: THERMOSONICATION	1714
Ayhan KARAKAŞ Ahmet ASLAN	THE EFFECT OF ORGANISATIONAL MOTIVATION OF FOOD AND BEVERAGE ESTABLISHMENTS EMPLOYEES ON THEIR PERFORMANCET	1719
Есенгельдиева Сауле Мергентгаевна	HISTORY AND DESIRE: AHMET BAITURSYNOV'S LITERARY WORLD	1728
Nafise SHOJA Yağmur BEYTEKİN	ANALYSIS WITH EXAMPLES OF DESIGN PRINCIPLES OF ENERGY EFFICIENT BUILDING CONSTRUCTED WITH SUSTAINABLE CONSTRUCTION TECHNIQUES IN HEALTHY CITIES	1740
Xalidə Ağadadaş qızı Talibova	UPBRINGING OF CHILDREN INCLUDED IN THE "RISK GROUP"	1791
Emilya ŞÜKÜROVA	CURRENT SITUATION OF DEMAND AND CONSUMPTION OF CANNING INDUSTRY PRODUCTS IN AZERBAIJAN	1799

YİYECEK İÇECEK İŞLETMELERİ ÇALIŞANLARININ ÖRGÜTSEL MOTİVASYONLARININ PERFORMANSLARINA ETKİSİ

THE EFFECT OF ORGANISATIONAL MOTIVATION OF FOOD AND BEVERAGE ESTABLISHMENTS EMPLOYEES ON THEIR PERFORMANCET

Ayhan KARAKAŞ

Doç. Dr., Bartın Üniversitesi İktisadi ve İdari Bilimler Fakültesi, Turizm İşletmeciliği Bölümü
(Sorumlu Yazar)

Ahmet ASLAN

Arş. Gör. Dr., Bartın Üniversitesi İktisadi ve İdari Bilimler Fakültesi, Turizm İşletmeciliği
Bölümü

ÖZET

Bu çalışma, günümüz yiyecek içecek sektöründe işletmelerin başarısını etkileyen faktörleri anlamayı ve özellikle çalışanların örgütsel motivasyonunun bireysel ve toplu performansları üzerindeki etkilerini incelemeyi amaçlamaktadır. Yüksek motivasyona sahip çalışanların iş yerinde daha mutlu ve bağlı oldukları, bu durumun ise iş görevlerini daha verimli ve kaliteli bir şekilde yerine getirmelerine katkı sağladığı gözlemlenmiştir. Bu bağlamda, çalışan motivasyonunun işletme başarısındaki rolü kritik öneme sahiptir. Çalışmanın ana odak noktalarından biri, yiyecek içecek işletmelerinde çalışanların motivasyonlarının örgütsel performanslarını nasıl etkilediğini anlamaktır. Çalışmanın yöntemi betimsel bir araştırma olarak belirlenmiş ve veri toplama aracı olarak anket formu kullanılmıştır. Veriler, 2022 yılında Ankara'daki yiyecek içecek işletmelerinde çalışan 600 işgörenden kolayda örnekleme yöntemi ile toplanmış ve çeşitli analizlerle değerlendirilmiştir. Çalışmanın sonucuna göre, ekonomik ve psiko-sosyal araçlar motivasyonunun çalışanların performanslarını etkilediğini fakat örgütsel yönetsel araçlar motivasyonunun çalışanların performanslarını etkilemediği tespit edilmiştir. Bu bulguların, yiyecek içecek işletmeleri için etkili insan kaynakları stratejileri ve yönetim pratiğine ışık tutması ve rekabet avantajlarını güçlendirmelerine yardımcı olması beklenmektedir.

Anahtar Kelimeler: örgütsel motivasyon, çalışan performansı, yiyecek içecek işletmeleri

ABSTRACT

This study aims to understand the factors that influence the success of businesses in today's food and beverage industry, particularly to examine the effects of employees' organizational motivation on their individual and collective performance. It has been observed that highly motivated employees are happier and more engaged at work, contributing to more efficient and high-quality performance of their work tasks. In this context, the role of employee motivation in business success is critical. One of the study's main focuses is understanding how employee motivation affects organizational performance in food and beverage businesses. The study method was determined as descriptive research, and a questionnaire form was used as a data collection tool. The data were collected from 600 employees working in food and beverage establishments in Ankara in 2022 by convenience sampling method and

evaluated by various analyses. According to the results of the study, it was found that economic and psycho-social means of motivation affect the performance of employees, but organizational managerial means of motivation do not affect the performance of employees. These findings are expected to shed light on effective human resource strategies and management practices for food and beverage businesses and help them strengthen their competitive advantage.

Keywords: organisational motivation, employee performance, food and beverage businesses

1. GİRİŞ

Günümüz iş dünyasında, başarılı işletmelerin sırlarını çözmek ve rekabet avantajını elde etmek giderek karmaşık hale gelmiştir. Özellikle yiyecek ve içecek sektörü, sürekli değişen tüketici talepleri, rekabetin yoğunluğu ve işletmelerin iç dinamikleri gibi faktörlerle karşı karşıya kalmaktadır. Yiyecek içecek sektörü, değişen tüketici talepleri, yoğun rekabet ve sektöre özgü dinamiklerle karakterize edilen karmaşık bir sektördür. Bu bağlamda, işletmelerin başarısının belirleyici faktörlerinden biri, çalışanların örgütsel motivasyon düzeyi ve bu motivasyonun performansları üzerindeki etkisidir.

Bu çalışma, özellikle yiyecek içecek işletmelerindeki çalışanların örgütsel motivasyonlarının, bireysel ve toplu performansları üzerindeki etkilerini anlamayı amaçlamaktadır. Yiyecek içecek sektörü hem hizmet sektörünün karmaşıklıklarıyla hem de ürün bazlı işletmelerin özel gereksinimleriyle öne çıkan bir sektördür. Yiyecek-içecek işletmeleri, rekabetin yoğun olduğu ve müşteri beklentilerinin yüksek olduğu bir sektördür. Bu işletmelerde çalışanların motivasyonu, işletmelerin başarısı için kritik öneme sahiptir. Yiyecek-içecek işletmelerinde çalışanlar, genellikle müşterilerle doğrudan etkileşim halindedirler. Çalışanların motivasyonu, müşteri memnuniyetini ve dolayısıyla işletmelerin karlılığını doğrudan etkiler. Bu nedenle, çalışanların motivasyonlarını anlamak ve bu motivasyonların işletmelerin genel performansına olan katkılarını değerlendirmek, sektöre özgü stratejik planlama ve yönetim uygulamalarının geliştirilmesine yönelik önemli bir adım olabilir.

Çalışmanın kapsamı, çalışan motivasyonunu etkileyen iç ve dış faktörleri analiz ederek, bu faktörlerin performans üzerindeki etkilerini ortaya koymayı hedeflemektedir. Ayrıca, bu etkileşimleri belirlemek için örgütsel motivasyonun farklı boyutları üzerinde odaklanarak, işletmelerin stratejik yönetimini optimize etme konusundaki literatürdeki boşlukları doldurmayı amaçlamaktadır.

Bu bağlamda, çalışmanın bulgularının, yiyecek içecek işletmeleri için etkili insan kaynakları stratejileri ve yönetim pratiğine ışık tutması ve bu sektördeki işletmelerin rekabet avantajlarını güçlendirmelerine yardımcı olması beklenmektedir.

2. LİTERATÜR TARAMASI

2.1. Örgütsel Motivasyon

Güdüleme ve güdülenme, motivasyonun iki farklı yönüdür. Güdüleme, “bir işi başarmak için bir insanın ya da insan topluluğunun çabalarını yoğunlaştırması amacı ile gerekli olan arzuyu ve inancı o kişi ya da insan grubuna vermek olarak” tanımlanabilir. Bir işi başarmak için duyulan arzu ve inancın kişiler üzerinde kendi kendine veya bir başkasının etkisi ile oluşması da güdüleme olarak adlandırılabilir (Tanrıverdi ve Oktay, 2001: 34; Köroğlu, 2011).

Örgütsel motivasyon, çalışanların iş hedeflerine ulaşmak için çaba göstermelerini sağlayan içsel ve dışsal faktörlerden oluşan bir süreçtir. İçsel motivasyon, çalışanların kendi içlerinde bulunduğu tatmin ve haz duygusundan kaynaklanır. Dışsal motivasyon ise, çalışanların dış kaynaklardan elde ettiği ödüller ve cezalardan kaynaklanır (Nadler ve Lawler, 197; Solmuş, 2004: 152).

2.2.İşgören Performansı

Performans, bireyler veya gruplar tarafından farklı şekillerde görülebilen çoklu uygulamaları olan bir kavramdır. Performans, bu kaygılarla belirlenen seviyeler açısından sonuçların ne kadar yakın gerçekleştirilebileceğinin bir ölçüsü olarak nitelendirilebilir. Bir şeyi etkileme gücü, bir görevi yerine getirme kapasitesi ve dayanıklılık gibi çeşitli senaryoları ifade eder (Luthans vd., 2008; Akova ve Aslan, 2018). Başka bir deyişle performans, bir kişinin, ekibin veya kuruluşun yapabileceklerinin, yani istenen sonuçla ilgili olarak sunabileceklerinin nicel ve nitel sınırlarını belirleyen fikir olarak tanımlanabilir. Bir işletmenin başarısı büyük ölçüde çalışanlarının performansına bağlı olduğundan, bireysel performans kurumun başarısı için çok önemlidir (Petty, McGee ve Cavender, 1984). Performans fikri artık yaygın bir şekilde karşımıza çıkmaktadır. Bu durum, insanların kendilerine verilen sorumlulukları ne kadar iyi yerine getirdikleri sorusunun önem kazanmasıyla ortaya çıkmıştır. İnsanlar görevlerini doğru bir şekilde yerine getirdiklerinde, bu durum yüksek performanslarının kanıtı olarak görülebilir; diğer yandan, görev ve sorumluluklarını tamamlamadıklarında veya yetersiz sonuçlar ürettiklerinde, bu durum düşük performanslarının kanıtı olarak görülebilir (Goodhue & Thompson, 1995; Gruman & Saks, 2011). Bir şirkette çalışanlar tarafından ortaya konan performanslar farklılık gösterebilir. Her çalışanın aynı düzeyde performans göstermesini beklemek gerçekçi değildir. Bu farklılık, bir kişinin genetik özelliklerinden veya yaşamının ilerleyen dönemlerinde edindiği özelliklerden kaynaklanabilir (Karakas ve Şahin, 2019; Çöl, 2008).

2.3.Örgütsel Motivasyon ve İşgören Performansı İlişkisi

Yiyecek içecek işletmelerinde örgütsel motivasyon ve bireysel performans arasında pozitif bir ilişki vardır. Bu ilişki, çalışanların iş tatminini, iş bağlılığını ve işteki üretkenliğini artırarak gerçekleşir. Yiyecek içecek işletmelerinde, çalışanların motivasyonu, iş tatmini, iş bağlılığı ve işteki üretkenliği gibi çeşitli faktörleri etkilemektedir. Yüksek motivasyona sahip çalışanlar, işyerinde daha mutlu ve bağlı olurlar. Bu da onların iş görevlerini daha verimli ve kaliteli bir şekilde yerine getirmelerine yardımcı olur (Bayram, 2017). Örgütsel motivasyon ve bireysel performans arasındaki ilişkiyi inceleyen çalışmalar, bu ilişkiyi destekleyen bulgular sunmaktadır. Taşpınar (2006), termal otel işletmelerinde çalışan 217 çalışmanı inceleyerek motivasyonu etkileyen faktörleri belirlemiştir. Araştırma, çalışanları motive etmek için finansal araçların psikososyal ve örgütsel-yönetimsel motivasyon araçlarından daha etkili olduğunu göstermiştir. İşgörenlerin motivasyonunu artıran en önemli araçlar olarak ortaya çıkan psikososyal motivasyon araçları, işverenin işini sevmesi, başarılı olması, saygın bir iş olması ve işinin yapılmaya değer olması. İşgörenlerin motivasyonu, gerekli olduğunda izin verilmesi, işinde sorumluluk verilmesi, yıllık izninin zamanında kullanılması, yöneticilerle ilişkiler ve müşteri memnuniyeti gibi örgütsel ve yönetimsel motivasyon araçlarından kaynaklanmaktadır. Ekonomik seçenekler arasında yemek, çay ve kahve gibi ikramların ücretsiz olarak verilmesi, ulaşım için servisin sağlanması ve bahşişlerin verilmesi, çalışanları motive etmeye yardımcı olabilir. Başka bir çalışmada ise, Ünlüönen vd. (2007) tarafından, psiko-sosyal motivasyon araçlarının belirlenmesi amacıyla 40 tane otelde çalışan toplam 233 işgören üzerinde bir araştırma yapılmıştır. Araştırma sonucunda; psiko-sosyal motivasyon araçları ile işgörenlerin verimliliği arasında istatistiksel olarak anlamlı bir ilişki ve güçlü bir bağ olduğu ortaya çıkmıştır

Yıldız, Savcı ve Kapu (2014), motive edici faktörlerin çalışanların iş performansını ve işten ayrılma isteğini nasıl etkilediği üzerine yaptıkları çalışmada, işin kendisi, ücret ve çalışma koşulları iş performansını olumlu yönde etkilerken, ücret, çalışma koşulları ve çalışan işbirliği gibi motive edici faktörlerin işten ayrılma isteğini olumsuz yönde etkilediği sonucuna varmışlardır. Chen ve Silverthorne (2008)'in bulgularına göre, güçlü bir iç kontrol odağına sahip olanlar tipik olarak iş yerinde daha az stres yaşamakta ve aynı zamanda daha yüksek

düzyeyde iş tatmini ve performans sergilemektedir. Dünder vd. (2007) tarafından otel işletmelerinde çalışan 217 çalışan üzerinde çalışanları motive eden unsurları belirlemek yapılan bir araştırma sonucu, içsel ve dışsal motivasyon kaynaklarının her ikisinin de çalışanların motivasyonunu etkilediğini göstermiştir. İşverenler için içsel motivasyon araçlarının etkisi (ilgi çekici ve zorlayıcı iş, bağımsızlık, işe katılım, sorumluluk, çeşitlilik, yaratıcılık, fırsatlar ve başarılı performansla ilgili tatmin edici geri bildirim) ve dışsal motivasyon araçlarına (çalışma ortamındaki kaynakların yeterliliği, ücret eşitliği, yükselme fırsatı, ek avantajlar, ödüller) göre daha yüksek çıkmıştır.

2.4.Araştırmanın hipotezleri

- H1.** Çalışanların ekonomik araçlar boyut motivasyonu performanslarını etkilemektedir.
- H2.** Çalışanların psiko-sosyal araçlar boyut motivasyonu performanslarını etkilemektedir.
- H3.** Çalışanların örgütsel yönetsel araçlar boyut motivasyonu performanslarını etkilemektedir.

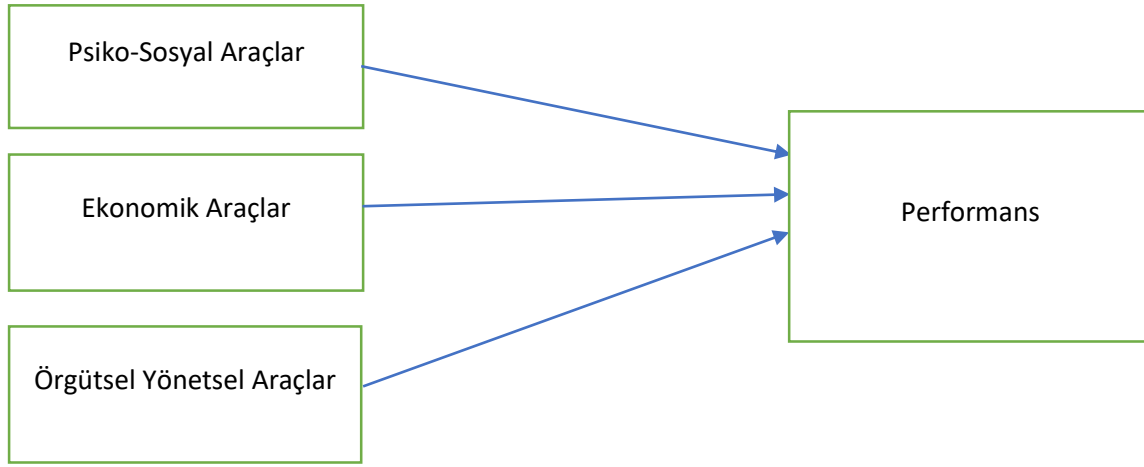

Şekil 1: Araştırmanın modeli

3. YÖNTEM

Bu çalışma betimsel bir araştırmadır. Çalışanların motivasyonları ve motivasyon düzeylerinin performanslarına etkisini ortaya koymayı amaçlamaktadır. Veri toplama aracı olarak anket formu kullanılmıştır. Anket formu üç bölümden oluşmaktadır. Birinci bölümde demografik özellikler, ikinci bölüm motivasyon düzeylerini ve üçüncü bölüm performans algılarının belirlemek için motivasyon ölçeği ve performans ölçeği yer almaktadır. Motivasyon ölçeği için, Zillmer (2003)'in geliştirdiği 13 soruluk ölçek; Köroğlu (2011)'nin çalışmasından alınan 18 soruluk ölçek, Antep vd. (2012)'nin hazırladığı ölçekten faydalanılarak üç boyutlu ve 17 ifadeli ölçek kullanılmıştır. Ölçek, ekonomik araçlar, psiko-sosyal araçlar ve örgütsel yönetsel araçlar olmak üzere üç alt boyuttan oluşmaktadır. Performans ölçeği, için Köroğlu'nun çalışmasındaki Kirkman ve Rosen (1999) tarafından geliştirilen Çöl (2008) tarafından Türkçeye çevrilen ölçekten yararlanılmıştır. Ölçekler likert tipi beşli derecelendirme ile düzenlenmiştir. 5'li derecelendirme (1) Kesinlikle Katılmıyorum ile (5) Kesinlikle Katılıyorum şeklinde derecelendirilmiştir. Veriler 2022 yılı içerisinde Nisan-Haziran döneminde Ankara'daki yiyecek içecek işletmeleri çalışanlarından toplanmıştır. Araştırmada kolayda örnekleme yöntemi ile 600 çalışandan veri toplanmıştır. Verilerin analizinde yüzde ve frekans analizi, güvenilirlik ve geçerlik analizleri, korelasyon ve regresyon analizleri yapılmıştır.

3.1.Bulgular

Araştırmaya katılan işgörenlerin demografik özellikleri Tablo 1’de gösterilmiştir.

Tablo 1. Araştırmaya Katılan Çalışanların Demografik Bulguları

Cinsiyet	N	Yüzde	Medeni Durum	N	Yüzde
Erkek	350	58	Evli	279	47
Kadın	250	42	Bekar	320	53
Toplam	600	100	Toplam	600	100
Yaş	N	Yüzde	Eğitim	N	Yüzde
18-30 Yaş	357	60	İlköğretim	139	23
31-40 Yaş	140	23	Lise	220	37
41-50 Yaş	81	14	Lisans	216	36
51 ve Üstü Yaş	20	3	Lisansüstü	25	4
Toplam	600	100	Toplam	600	100

Tablo 1 incelendiğinde çalışmaya katılan işgörenlerin çoğunluğunun %58’lik oranla erkek çalışanlardan, %42’sinin ise erkek işgörenlerden oluştuğu görülmektedir. İşgörenler medeni durumları bakımından analiz edildiğindeyse %47’sinin bekar, %53’ünün ise evli olduğu tespit edilmiştir. İşgörenlerin %60’ının 18-30 yaş grubunda, %23’ünün 31-40 yaş grubunda ve %14’ünün 41-50 yaş grubunda olduğu görülmektedir. Buna göre turizm endüstrisinin dinamik yapısı göz önünde bulundurulduğunda işgörenleri büyük oranda gençlerin oluşturduğu söylenebilir. İşgörenler eğitim durumları yönünden ele alındığında %37’sinin lise, %36’sının lisans ve %23’ünün ilköğretim mezunu olduğu görülmektedir.

Tablo 2. Değişkenler Arasındaki Korelasyonların İncelenmesi

	Ort.	St. sapma	1	2	3	4
1.Performans	4,22	0,60	1			
2.Psiko-Sosyal Araçlar	4,48	0,56	,187**	1		
3.Ekonomik Araçlar	4,64	0,40	,201**	,337**	1	
4.Örgütsel Yönetmel Araçlar	4,53	0,70	,550**	,240**	,246**	1
**. Correlation is significant at the 0.01 level (2-tailed).						

Tablo 2’deki verilere göre katılımcıların örgütsel motivasyon boyutlarından ekonomik araçlar ortalamasının diğer boyutlara göre yüksek olduğu anlaşılmaktadır. Buna göre, işgörenler ücretlerinin düzenli olarak artmasını, iş güvencesinin olmasını, başarılarından ötürü ödüllendirilmelerini ve işletmelerinin kendilerine sunduğu ücretsiz servis, öğle yemeği gibi imkanların kendilerini motive ettiğini ifade etmişlerdir. Tablo 2 incelendiğinde performans ile psiko-sosyal araçlar arasında pozitif yönlü ve zayıf düzey bir ilişki; performans ile ekonomik araçlar arasında pozitif yönde zayıf bir ilişki; performans ile örgütsel yönetmel araçlar arasında pozitif yönlü ve orta düzey bir ilişki tespit edilmiştir. Literatürde yapılan çalışmalar incelendiğinde çoğunlukla örgütsel motivasyon ile performans arasında pozitif bir ilişki olduğu sonucuna ulaşılmaktadır. Dolayısıyla bu çalışmanın sonuçları önceki çalışmaların sonuçlarıyla benzerlik göstermektedir.

Tablo 3. Örgütsel Motivasyon ve İşgören Performansı Düzeylerinin Cinsiyete Göre t-testi Sonuçları

Değişkenler	Gruplar	Kişi Sayısı (N)	Ortalama (X)	Std. sapma	t testi	
					t	p
Örgütsel Motivasyon	Kadın	250	4,22	,53403	-,079	,937
	Erkek	350	4,22	,64742		
İşgören Performansı	Kadın	250	4,52	,35936	-,779	,436
	Erkek	350	4,54	,46019		

Araştırmaya katılan işgörenlerin cinsiyet değişkeni açısından örgütsel motivasyonu ve işgören performansları karşılaştırılmıştır ve 0,05 anlamlılık seviyesinde bir farklılaşma görülmemiştir ($p>0,05$). Dolayısıyla kadın ve erkek çalışanların örgütsel motivasyonu ve işgören performanslarında anlamlı bir farklılık tespit edilememiştir.

Tablo 4. Örgütsel Motivasyon ve İşgören Performansının Medeni Durumlarına Göre t-testi Sonuçları

Değişkenler	Gruplar	Kişi Sayısı (N)	Ortalama (X)	Std. sapma	t testi	
					t	p
Örgütsel Motivasyon	Evli	250	4,22	,62490	,097	,922
	Bekar	350	4,22	,58270		
İşgören Performansı	Evli	250	4,52	,41422	-,660	,510
	Bekar	350	4,54	,41637		

Araştırmaya katılan işgörenlerin medeni durum yönünden örgüt motivasyonu ve işgören performansları karşılaştırılmıştır ve 0,05 anlamlılık seviyesinde bir farklılaşma görülmemiştir ($p>0,05$). Evli ve kadın işgörenlerin örgütsel motivasyonu ve işgören performanslarında anlamlı bir farklılık tespit edilememiştir.

Tablo 5. Örgütsel Motivasyon ve İşgören Performansının Eğitim Durumlarına Göre Farklılıklarını Gösteren Anova Testi

Boyutlar	Gruplar	Kişi Sayısı (N)	Ortalama (X)	Std. sapma	F	p
İşgören Performansı	İlköğretim (1)	139	4,27	,52033	2,164	,091
	Lise (2)	220	4,14	,66904		
	Lisans (3)	216	4,25	,56617		
	Lisansüstü (4)	25	4,34	,66608		
Örgütsel Motivasyon	İlköğretim (1)	139	4,57	,40486	1,570	,195
	Lise (2)	220	4,51	,41060		
	Lisans (3)	216	4,51	,43871		
	Lisansüstü (4)	25	4,67	,42894		

Araştırmaya katılan işgörenlerin eğitim durumu açısından örgütsel motivasyonu ve işgören performansları karşılaştırılmıştır ve 0,05 anlamlılık seviyesinde bir farklılaşma görülmemiştir ($p>0,05$). Eğitim seviyeleri farklı olan işgörenlerin örgütsel motivasyonlarının ve işgören performanslarının birbirinden farklı olmadığı tespit edilmiştir. Ayrıca araştırmaya katılan işgörenlerin yaş değişkeni açısından örgütsel motivasyonu ve işgören performansları karşılaştırılmıştır ve 0,05 anlamlılık seviyesinde bir farklılaşma görülmemiştir ($p>0,05$).

Ayrıca işgörenlerin örgütsel motivasyon alt boyutlarının performans üzerindeki etki düzeyini belirlemek amacıyla basit regresyon analizi yürütülmüştür ve analizi sonuçları Tablo 6'da görülmektedir.

Tablo 6. Örgütsel Motivasyon Boyutlarının Performansa Etkisini İnceleyen Çoklu Regresyon Analizi

Değişken	Standartlaştırılmamış Katsayılar		Standartlaştırılmış Katsayılar		
	β	Standart Hata	β	t	Sig.
(Sabit)	2,493	,302		8,250	,000
Psiko-Sosyal Araçlar	,142	,046	,133	3,095	,002
Ekonomik Araçlar	,227	,063	,153	3,572	,000
Örgütsel Yönetmel Araçlar	,010	,035	,011	,269	,788
R=,238 R ² = ,057 Düzeltilmiş R ² =,052 F=11,920 Sig. = ,000					
Bağımlı Değişken: Performans					

Modele göre örgütsel motivasyon alt boyutlarının, performansı açıklama oranı %5,2'dir. Analiz sonuçlarına göre psiko-sosyal araçlar ($\beta=,142$; $p<0,05$) ve ekonomik araçlar ($\beta=,227$; $p<0,05$) boyutları performansı pozitif yönden etkilemektedir. İşgörenler, işletmede yüksek motivasyona sahip olduklarında performansları da artacaktır. Buna göre H1 ve H2 hipotezi desteklenmektedir. Bu sonuç önceki araştırma sonuçlarını da desteklemektedir (Koçak & Özüdoğru, 2012; Ece, Tokgözoğlu & Oğuz, 2021). Ayrıca örgütsel yönetmel araçların performans üzerinde anlamlı bir etkisi bulunmamaktadır. Dolayısıyla H3 hipotezi reddedilmiştir ve literatürde benzer araştırma sonuçlarına ulaşan çalışmalar da bu sonucu desteklemektedir (Ritz, 2009; Fernandez & Moldogaziev, 2013).

SONUÇ VE ÖNERİLER

Çalışma kapsamında Ankara'da faaliyet gösteren yiyecek-içecek işletmelerinde çalışan işgörelere yüz yüze anket uygulanmıştır. Gruplar arasında yapılan fark testlerine göre, araştırmaya katılan işgörelerin cinsiyet değişkeni açısından örgütsel motivasyonu ve işgörel performansları karşılaştırılmıştır ve 0,05 anlamlılık seviyesinde bir farklılaşma görülmemiştir ($p>0,05$). Dolayısıyla kadın ve erkek çalışanların örgütsel motivasyonu ve işgörel performanslarında anlamlı bir farklılık tespit edilememiştir. Ayrıca çalışmaya katılan işgörelerin medeni durum yönünden örgüt motivasyonu ve işgörel performansları karşılaştırılmıştır ve 0,05 anlamlılık seviyesinde bir farklılaşma görülmemiştir ($p>0,05$). Araştırmaya katılan işgörelerin eğitim durumu ve yaş değişkeni açısından örgütsel motivasyonu ve işgörel performansları karşılaştırılmıştır ve 0,05 anlamlılık seviyesinde bir farklılaşma görülmemiştir ($p>0,05$).

Analiz sonucuna göre, değişkenlerin ortalaması incelendiğinde genel olarak ortalamanın üstünde değerlere sahip oldukları görülmektedir. Ayrıca, katılımcıların örgütsel motivasyon boyutlarından ekonomik araçlar ortalamasının diğer boyutlara göre yüksek olduğu anlaşılmaktadır. Buna göre, işgörel ücretlerinin düzenli olarak artmasını, iş güvencesinin

olmasını, başarılarından ötürü ödüllendirilmelerini ve işletmelerinin kendilerine sunduğu ücretsiz servis, öğle yemeği gibi imkanların kendilerini motive ettiğini ifade etmişlerdir. Yapılan korelasyon analizi sonucuna göre, performans ile psiko-sosyal araçlar arasında pozitif yönde zayıf düzey bir ilişki; performans ile ekonomik araçlar arasında pozitif yönde zayıf bir ilişki; performans ile örgütsel yönetsel araçlar arasında pozitif yönde ve orta düzeyde ilişki bulunmuştur.

Elde edilen bulgular psiko-sosyal ve ekonomik araç motivasyonlarının işgörenlerin performansı üzerinde etkili olduğunu göstermiştir. Bu sonuç önceki araştırma sonuçlarını da desteklemektedir (Koçak & Özüdoğru, 2012; Ece, Tokgözoğlu & Oğuz, 2021). Etki açısından ekonomik araçların diğer araçlara kıyasla performans üzerinde daha yüksek etkiye sahip olduğu saptanmıştır.

KAYNAKLAR

- Antep, Z., Bektaş, G., Altın, U., & İrbán, A. (2012). For strategic planning of healthcare management, the effect of mobbing on motivation of healthcare providers. *Procedia-Social and Behavioral Sciences*, 58, 606-613.
- Akova, O., & Aslan, A. (2018). Liderlik davranışı ile örgütsel seslilik ve çalışan performansı ilişkisi: otel çalışanları üzerine bir araştırma. *Sosyal Bilimlerde Akademik Çalışmalar*, Gece Kitaplığı, Ankara.
- Bayram, G. E. (2017). Motivasyonun Demografik ve Mesleki Özelliklere Göre Farklılaşması: Turist Rehberleri Üzerine Bir Araştırma. *Journal of Yaşar University*, 12(28), 257-271.
- Chen, J. C., & Silverthorne, C. (2008). The impact of locus of control on job stress, job performance and job satisfaction in Taiwan. *Leadership & Organization Development Journal*, 29(7), 572-582.
- Çöl, G. (2008). Algılanan Güçlendirmenin İşgören Performansına Etkisi. *Doğuş Üniversitesi Dergisi*, 9(1), 35-46.
- Dündar, S., Özutku, H., & Taşpınar, F. (2007). İçsel ve dışsal motivasyon araçlarının işgörenlerin motivasyonu üzerindeki etkisi: Ampirik bir inceleme. *Gazi Üniversitesi Ticaret ve Turizm Eğitim Fakültesi Dergisi*, (2), 105-119.
- Ece S., Tokgözoğlu, S., & Oğuz, D. (2021). İşyerinde kötü muamele, motivasyon ve performans ilişkisi. *Dicle Üniversitesi İktisadi ve İdari Bilimler Fakültesi Dergisi*, 11(21), 108-125.
- Fernandez, S., & Moldogaziev, T. (2013). Using employee empowerment to encourage innovative behavior in the public sector. *Journal of public administration research and theory*, 23(1), 155-187.
- Goodhue, D. L., & Thompson, R. L. (1995). Tasktechnology fit and individual performance. *MIS Quarterly*, 19(2), 213-236.
- Gruman, J. A., & Saks, A. M. (2011). Performance management and employee engagement. *Human Resource Management Review*, 21(2), 123-136.
- Karakaş, A., & Şahin, N. (2017). The relation between work family life conflict, job performance and job stress: a research on hotel employee. *Sosyoekonomi*, 32(25), 51-
- Karakaş, A., & Şahin, N. (2019). The Relation Between Work Stress, Work-Family Life Conflict and Worker Performance: A Research Study on Hospitality Employees, *European Journal of Tourism Research*, 21, 102-118.
- Kirkman, B. L., & Rosen, B. (1999). Beyond self-management: Antecedents and consequences of team empowerment. *Academy of Management Journal*, 42, 58-74.

- Koçak, R. D., & Özudođru, H. (2012). Yöneticilerin liderlik özelliklerinin çalışanların motivasyonu ve performansı üzerindeki etkileri: Kamu ve özel hastanelerinde bir uygulama. *Gazi Üniversitesi Ticaret ve Turizm Eğitim Fakültesi Dergisi*, (1), 76-88.
- Korođlu, Ö. (2011). İş Doyumu ve Motivasyon Düzeylerini Etkileyen Faktörlerin Performansla İlişkisi: Turist Rehberleri Üzerine Bir Araştırma. Doktora Tezi, Balıkesir Üniversitesi, Sosyal Bilimler Enstitüsü ABD. Balıkesir.
- Luthans, F., Norman, S. M., Avolio, B. J., & Avey, J. B. (2008). The mediating role of psychological capital in the supportive organizational climate—employee performance relationship. *Journal of Organizational Behavior*, 29(2), 219-238
- Luthans, F., Norman, S. M., Avolio, B. J., & Avey, J. B. (2008). The mediating role of psychological capital in the supportive organizational climate—employee performance relationship. *Journal of Organizational Behavior: The International Journal of Industrial, Occupational and Organizational Psychology and Behavior*, 29(2), 219-238.
- Nadler, D., & Lawler, E. E. (1977). *Motivation: A diagnostic approach* (pp. 25-36). OR & C, Organizational Research and Consultation.
- Petty, M. M., McGee, G. W., & Cavender, J. W. (1984). A meta-analysis of the relationships between individual job satisfaction and individual performance. *Academy of Management Review*, 9(4), 712-721.
- Ritz, A. (2009). Public service motivation and organizational performance in Swiss federal government. *International review of administrative sciences*, 75(1), 53-78.
- Solmuş, T. (2004). İş Yaşamında Duygular ve Kişilerarası İlişkiler; Psikoloji Penceresinden İnsan Kaynakları Yönetimi. İstanbul: Beta Yayınları.
- Tanrıverdi, H., & Oktay, K. (2001). Otel işletmelerinde işgören motivasyonuna yönelik bir araştırma.
- Taşpınar, F. (2006). *Motivasyon araçlarının işgören motivasyonu üzerindeki etkisi: Afyonkarahisar ilindeki termal otel işletmelerinde bir araştırma* (Master's thesis, Afyon Kocatepe Üniversitesi, Sosyal Bilimler Enstitüsü).
- Ünlüönen, K., Ertürk, M., Olcay, A., ÜNLÜÖNEN, K., & ERTÜRK, M. (2007). OTEL İŞLETMELERİNDE PSİKO-SOSYAL MOTİVASYON ARAÇLARI VE BU ARAÇLARIN FARKLI DEPARTMANLAR ÜZERİNDEKİ ETKİSİNE YÖNELİK ANKARA ve İZMİR OTELLERİNDE BİR UYGULAMA. *Elektronik Sosyal Bilimler Dergisi*, 6(19), 9-32.
- Yıldız, S., Savcı, G., & Kapu, H. (2014). Motive edici faktörlerin çalışanların iş performansına ve işten ayrılma niyetine etkisi. *Yönetim ve Ekonomi*, 21(1), 233-249.
- Zillmer, E.A. (2003). The neuropsychology of repeated 1- and 3-meter springboard diving among college athletes. *Applied Neuropsychology*, 10, 23-30.